

# ET Series Electric Cylinders

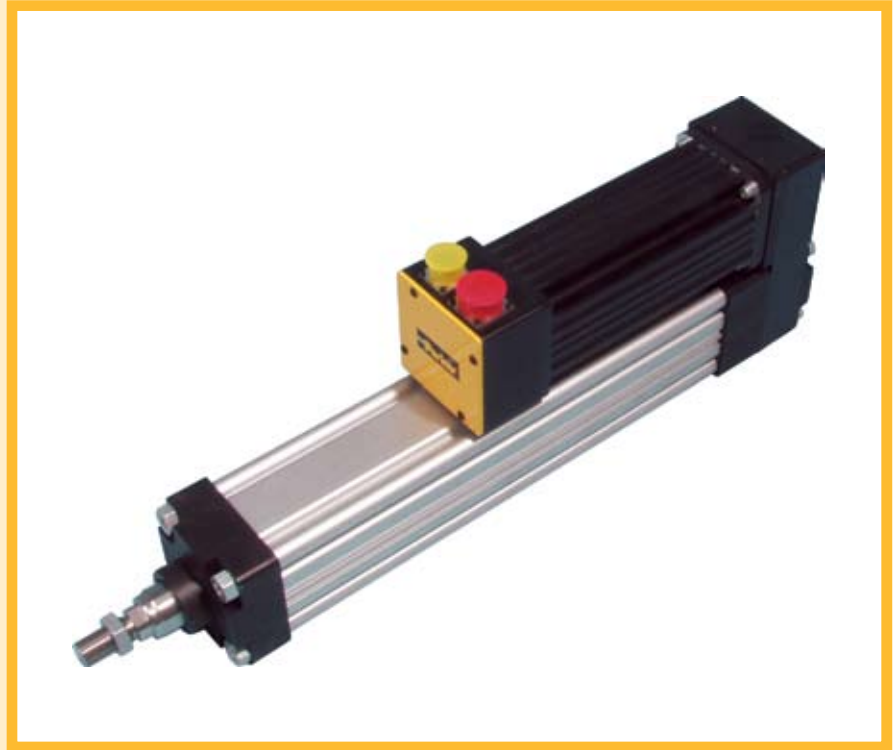

## Contents

Introduction.....	2
Features .....	3
Specifications .....	4
Technical Data	
Performance Curves .....	6
Rod Side Loading .....	10
Life Expectancy.....	11
Rod Guide Module .....	12
Basic Dimensions.....	14
Options	
Mounting Options.....	16
Rod End Options.....	18
Linear Alignment Coupler .....	20
Brake.....	20
Special Modifications.....	21
Sensors .....	22
Ordering Information.....	24
Application Fax Form.....	26

Parker Hannifin Corporation  
Actuator Division  
Wadsworth, Ohio USA  
Phone: 1-866-PARK-ACT  
email: [actuatorsales@parker.com](mailto:actuatorsales@parker.com)  
website: [www.parker.com/actuator](http://www.parker.com/actuator)

## The ET Series Electric Cylinder

The automation industry demands flexibility and durable design. The ET Series Electric Cylinder serves both demands. Introduced as the world's first complete stepper and servo driven electric cylinder system, the ET Series combines an unparalleled design with a variety of options that make it easy to integrate into both new and existing applications.

Produced to hard metric ISO standards, the ET Series can mount into existing fluidpower cylinder applications, adding infinite programmability to the durability and long life expected of hydraulic and pneumatic cylinders. Its modular design includes nine different actuator mounting styles in addition to available custom mounting. The ET Series' range of five profile sizes present the user with the flexibility to configure the actuator to the application.

Combined with a Parker Hannifin motor and control system, the ET Series arrives at the customer's dock complete and ready to mount. Backed by an industry-leading 2 year warranty and Parker Hannifin's worldwide customer support network, the ET Series is a global automation solution.



## ET Markets and Applications

With thousands of axes installed worldwide, the ET series electric cylinder has proven to be a robust and reliable solution for numerous motion control applications across many markets and industries. Listed below are some examples of where and how the ET series electric cylinder has been successfully applied.

### Markets and Industries Served

Automotive	Transportation	Machine Tool
Tire & Rubber	Wood & Lumber	Aerospace
Packaging	Conveyor	Military
Food & Beverage	Medical	Semiconductor
Glass / Fiber	Recreation / Amusement Park	Plastics
Computer / Electronics	Pharmaceutical	Factory Automation

### Application Examples

Force / Position Control	Discrete / Multi-Point Positioning	Reach In & Retract	Complex Motion Control
Assembly Presses	Vertical Stackers / Elevator Lift	Inspection / Measurement	Flight / Motion Simulation
Weld Gun Actuation	Door & Hatch Closures	Labeling / Marking	Flying Die Cut-to-Length
Parts Clamping	Lane Diverters	Parts Load / Unload	Mechanical Cam Replacement
Tube Bending	Mold Toggle	Tool Change	Web Edge Guiding
Joining / Fastening	Backstop / Blade positioning	Z-Axis Pick & Place	Contoured Glue Dispensing
Molding / Forming / Stamping	Volumetric Dispensing / Filling	Automated Assembly	Servo Valve Control
Compression Packing	Medical Bed Actuation	Hydraulic & Pneumatic Replacement	Web Tension Control

## Construction Inline Motor Mounting Shown

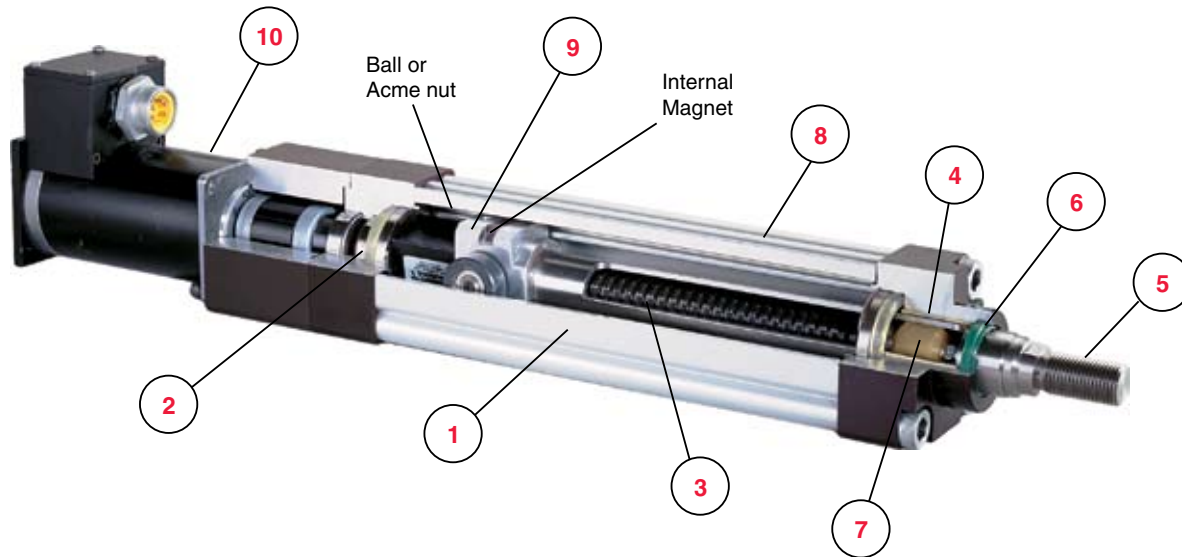

### 1 Five Profile Sizes (32, 50, 80, 100, 125)

With thrust capacity ranging from 135 lbf to 10,000 lbf, the ET series electric cylinder is designed to fit a wide range of applications.

### 2 High Capacity Thrust Bearings

Dual angular contact thrust bearings are pre-loaded to eliminate axial play and provide high thrust capacity.

### 3 Precision Ball or Acme Screw Drive

High efficiency, precision rolled ball screws allow for continuous duty operation and long, reliable life.

Quality acme screws are less efficient than ball screws and are well suited for failsafe (self-locking) vertical loads and lower duty cycles.

### 4 Long Length Rod Bearing

The extra long rod bearing design reduces bearing pressure allowing higher side load capacity and life.

### 5 Precision Stainless Steel Rod

The cylinder rod is ground and polished stainless steel which provides long life and corrosion resistance.

### 6 Combination Lip & Wiper Seal

The lip and wiper seal keeps contaminants out and lubricating grease in, increasing actuator life.

### 7 Screw Shaft Nose Bearing

The substantial support provided by the screw nose bearing eliminates whipping, vibration, and run out.

### 8 Extruded Limit Sensor Grooves

Sensor grooves are incorporated into the anodized extrusion body design allowing for easy placement and adjustment. An internal magnet is used as a target for the external Hall effect or reed sensors.

### 9 Precision Anti-Rotation Bearing Carriage

The anti-rotation bearing carriage rigidly supports the screw while eliminating rod play and prolonging screw life.

### 10 Parker Motor/Gearbox Mounting Options

The ET electric cylinder can be supplied with a number of different Parker stepper or servo motors as well as precision gearboxes for increased mechanical resolution.

### 11 Parallel Motor Mount with Timing Belt

Motor mount can be wrapped or rotated in all directions to optimize overall envelope dimension.

### 12 Parallel Motor Mount with Gear Drive

Optional gear drive parallel mount allows for higher thrust capacity and reduction ratios than the timing belt drive.

## Parallel Motor Mounting with Timing Belt



## Parallel Motor Mounting with Gear Drive

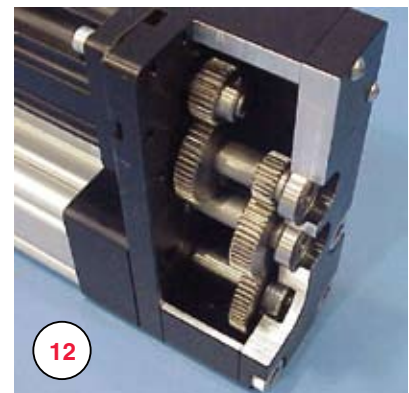

## ET Specifications

ET-Screw Overview	Units	ET032				ET050				ET080			
		A08	A04	B08	B02	A05	B05	B02	B01	A04	B04	B02	B01
<b>Performance Limits</b>													
Max Thrust Fx	lbf (N)	135 (600)				720 (3200)				1600 (7120)			
Max Speed	in/s	15.6	31.2	15.6	50.0	25.0	15.8	39.6	60.0	31.2	12.5	25.0	50.0
Max Speed	mm/s	396	792	396	1270	635	401	1006	1524	792	317	635	1270
Max Acceleration	in/s <sup>2</sup> (m/s <sup>2</sup> )	386 (9.8)				386 (9.8)				386 (9.8)			
Max Travel	in (mm)	59.0 (1000)				59.0 (1500)				59.0 (1500)			
<b>System Characteristics</b>													
Screw Lead	in/rev	0.125	0.250	0.125	0.500	0.200	0.200	0.500	1.000	0.250	0.250	0.500	1.000
Efficiency - inline <sup>1</sup>	%	48%	63%	90%	90%	44%	90%	90%	90%	38%	90%	90%	90%
Max Breakaway Torque	oz-in	45	52	39	50	53	47	49	60	200	136	140	148
Repeatability <sup>2</sup> - inline / parallel	in	±0.001 / ±0.006				±0.001 / ±0.006				±0.001 / ±0.006			
System Backlash <sup>3,4</sup>	in	—	—	0.003	0.003	—	0.005	0.005	0.005	-	0.007	0.007	0.007
<b>Reflected Rotational Inertia</b>													
Base Inline Unit Inertia, 100mm travel	oz-in <sup>2</sup>	0.03	0.03	0.04	0.25	0.20	0.33	0.33	0.63	2.0	2.8	3.0	3.0
Base Parallel Unit Inertia, 100mm travel	oz-in <sup>2</sup>	0.04	0.04	0.04	0.26	0.21	0.34	0.34	0.64	2.1	2.8	3.1	3.1
Additional Inertia per 100mm travel	oz-in <sup>2</sup> / 100mm	0.02	0.02	0.02	0.09	0.11	0.17	0.17	0.20	0.9	1.2	1.2	1.2
<b>Weight &amp; Inertia Data</b>													
Base Unit Weight, 100mm travel	lb (kg)	2.86 (1.3)				5.06 (2.3)				15.0 (6.8)			
Additional Travel Weight	lb (kg) / 100mm	0.66 (0.33)				1.32 (0.66)				2.2 (1.0)			

1. Parallel driven unit efficiency = inline efficiency x 0.9

2. Repeatability is unidirectional achieved under ideal conditions and slow speeds. Actual repeatability may vary with the application

3. ACME screw backlash will increase over time due to the nature of the friction bearing. Initial values <0.009"

4. Zero-backlash, pre-loaded ball screws are available as a special option. Thrust capacity and life may be derated with preloaded option.

## Critical Speeds

Model	Lead	Critical Speed: mm/s (in/s) vs. Stroke: mm							
		50 - 200	300	450	600	750	1000	1250	1500
ET032	A08	396 (15.6)	325 (12.7)	165 (6.5)	100 (3.9)	70 (2.7)	50 (1.9)	—	—
	A04	792 (31.2)	651 (25.6)	331 (13.0)	200 (7.8)	139 (5.4)	100 (3.9)	—	—
	B08	423 (16.6)	339 (13.3)	174 (6.8)	106 (4.1)	74 (2.9)	54 (2.1)	—	—
	B02	1270 (50)	1270 (50)	779 (30.6)	480 (18.8)	325 (12.7)	225 (8.8)	—	—
ET050	A05	635 (25.0)	634 (24.9)	332 (13.0)	204 (8.0)	138 (5.4)	88 (3.4)	66 (2.6)	48 (1.9)
	B05	403 (15.8)	403 (15.8)	403 (15.8)	257 (10.1)	175 (6.8)	113 (4.4)	87 (3.4)	64 (2.5)
	B02	1006 (39.6)	1006 (39.6)	1006 (39.6)	642 (25.2)	438 (17.2)	282 (11.1)	219 (8.6)	157 (6.1)
	B01	1524 (60.0)	1524 (60.0)	1524 (60.0)	1524 (60.0)	876 (34.4)	563 (22.1)	438 (17.2)	305 (12.0)
ET080	A04	792 (31.2)	792 (31.2)	674 (26.5)	426 (16.7)	293 (11.5)	178 (7.0)	125 (4.9)	91 (3.5)
	B04	318 (12.5)	318 (12.5)	318 (12.5)	318 (12.5)	318 (12.5)	203 (8.0)	144 (5.6)	106 (4.1)
	B02	635 (25.0)	635 (25.0)	635 (25.0)	635 (25.0)	635 (25.0)	393 (15.5)	282 (11.1)	206 (8.1)
	B01	1270 (50.0)	1270 (50.0)	1270 (50.0)	1270 (50.0)	1270 (50.0)	785 (30.9)	565 (22.2)	414 (16.2)

## ET Specifications

ET-Screw Overview	Units	ET100				ET125			
		A04	B04	B02	B53	M05	M10	M20	M50
<b>Thrust &amp; Speed Limits</b>									
Max Thrust Fx	lbf (N)	5300 (23500)				10000 (44500)			
Max Speed	in/s	15.6	31.2	15.6	50.0	25.0	15.8	39.6	60.0
Max Speed	mm/s	396	792	396	1270	635	401	1006	1524
Max Acceleration	in/s <sup>2</sup> (m/s <sup>2</sup> )	386 (9.8)				386 (9.8)			
Max Travel	in (mm)	59.0 (1500)				59.0 (1500)			
<b>System Characteristics</b>									
Screw Lead	in/rev	0.250	0.250	0.500	1.875	5mm	10mm	20mm	50mm
Efficiency - inline <sup>1</sup>	%	30%	90%	90%	90%	90%	90%	90%	90%
Max Breakaway Torque	oz-in	385	350	375	390	370	375	380	400
Repeatability <sup>2</sup> - inline / parallel	in	±0.001 / ±0.006				±0.001 / ±0.006			
System Backlash <sup>3,4</sup>	in	-	-	0.008	0.008	-	0.005	0.005	0.005
<b>Reflected Rotational Inertia</b>									
Base Inline Unit Inertia, 100mm travel	oz-in <sup>2</sup>	35.3	34.7	39.0	40.2	38.0	45.1	46.4	53.0
Base Parallel Unit Inertia, 100mm travel	oz-in <sup>2</sup>	37.4	36.7	41.0	42.2	40.2	48.7	51.1	58.5
Additional Inertia per 100mm travel	oz-in <sup>2</sup> / 100mm	8.6	8.2	8.0	8.0	8.2	8.1	8.1	8.1
<b>Weight &amp; Inertia Data</b>									
Base Unit Weight, 100mm travel	lb (kg)	31.5 (14.3)				62.0 (28.2)			
Additional Travel Weight per 100mm travel	lb (kg) / 100mm	4.4 (2.0)				9.24 (4.4)			

1. Parallel driven unit efficiency = inline efficiency x 0.9

2. Repeatability is unidirectional achieved under ideal conditions and slow speeds. Actual repeatability may vary with the application

3. ACME screw backlash will increase over time due to the nature of the friction bearing. Initial values <0.009"

4. Zero-backlash, pre-loaded ball screws are available as a special option. Thrust capacity and life may be derated with preloaded option.

## Critical Speeds

Model	Lead	Critical Speed: mm/s (in/s) vs. Stroke: mm							
		50 - 200	300	450	600	750	1000	1250	1500
ET100	A04	792 (31.2)	792 (31.2)	792 (31.2)	694 (27.3)	482 (18.9)	295 (11.6)	199 (7.8)	143 (5.6)
	B04	212 (8.3)	212 (8.3)	212 (8.3)	212 (8.3)	212 (8.3)	212 (8.3)	212 (8.3)	155 (6.1)
	B02	423 (16.7)	423 (16.7)	423 (16.7)	423 (16.7)	423 (16.7)	423 (16.7)	351 (13.8)	257 (10.1)
	B53	1588 (62.5)	1588 (62.5)	1588 (62.5)	1588 (62.5)	1588 (62.5)	1588 (62.5)	1305 (51.3)	957 (37.6)
ET125	M05	200 (7.9)	200 (7.9)	200 (7.9)	197 (7.7)	137 (5.4)	85 (3.3)	57 (2.2)	41 (1.6)
	M10	400 (15.7)	400 (15.7)	400 (15.7)	374 (14.7)	264 (10.4)	164 (6.4)	112 (4.4)	81 (3.2)
	M20	533 (20.9)	533 (20.9)	533 (20.9)	533 (20.9)	522 (20.5)	326 (12.8)	223 (8.7)	162 (6.3)
	M50	1333 (52.5)	1333 (52.5)	1333 (52.5)	1333 (52.5)	1233 (48.5)	781 (30.7)	538 (21.1)	393 (15.4)

## Operating Temperature Range

0°C to 60°C (32°F to 140°F)

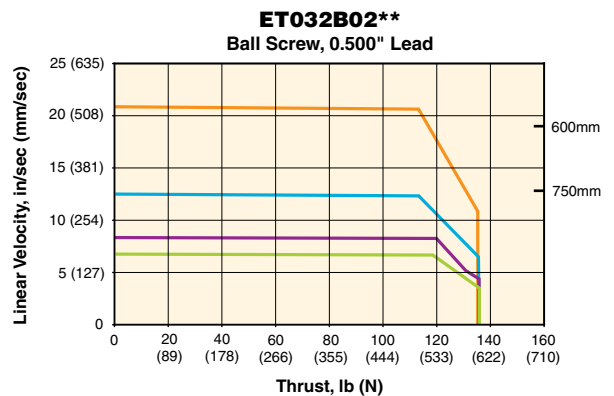
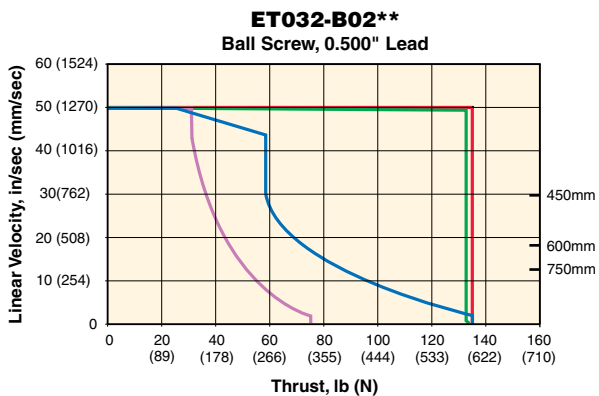
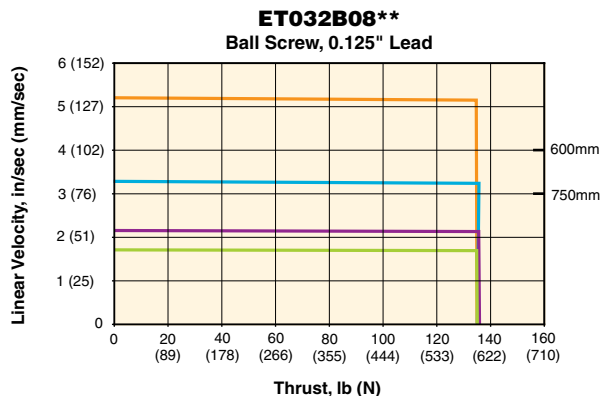
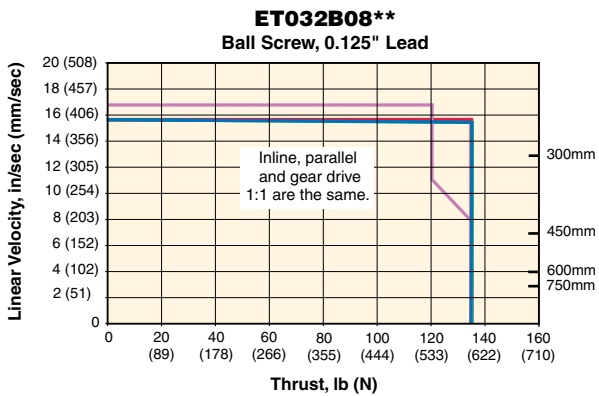
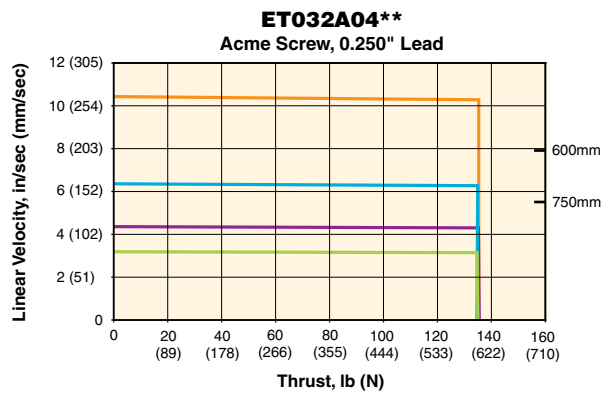
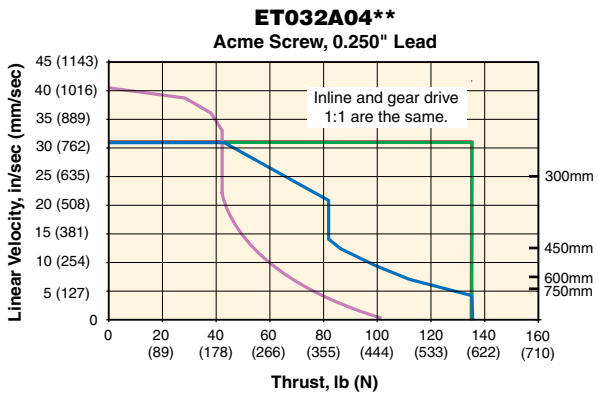
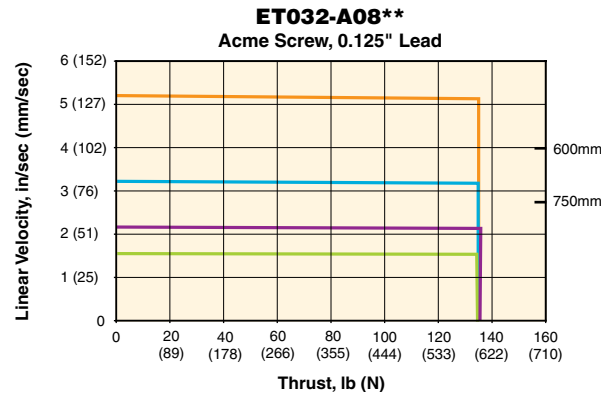
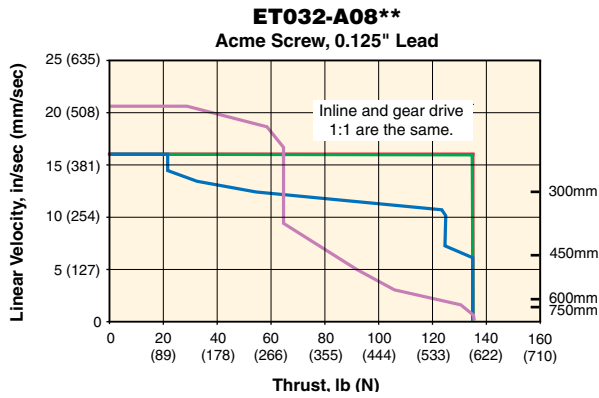

Inline Mount	Parallel Mount		
	Direct Drive	Timing Belt	Gear Drive
1:1	1:1	1:1.5	1:1

Maximum velocity is limited for longer stroke lengths. Reference stroke limits on right edge of graphs.

Parallel Mount			
Gear Drive			
3:1	5:1	7.5:1	9.5:1



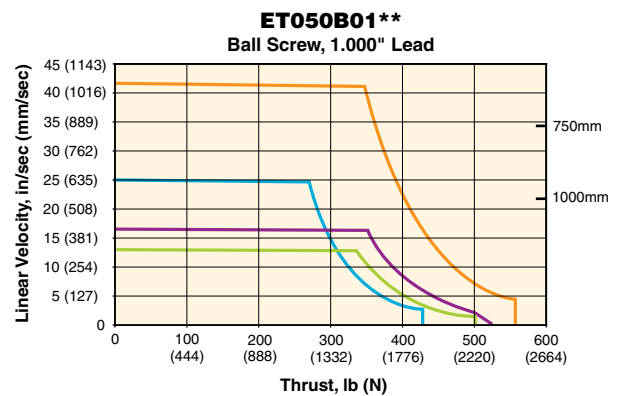
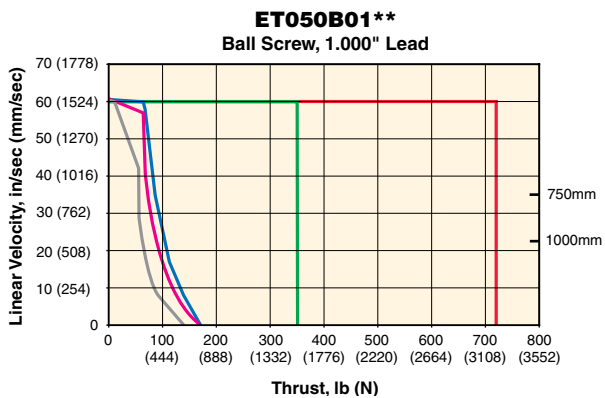
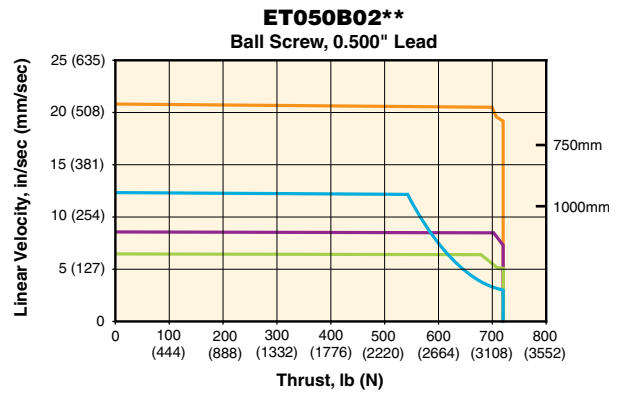
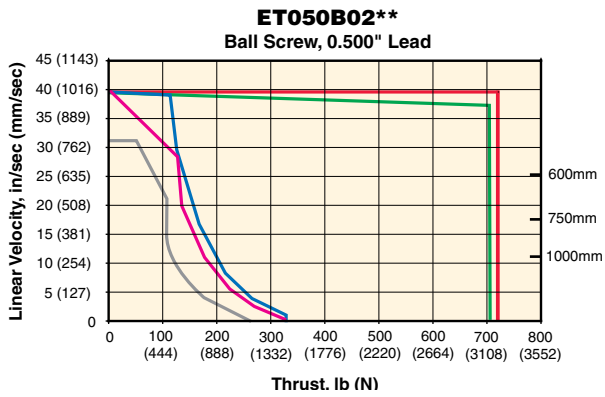
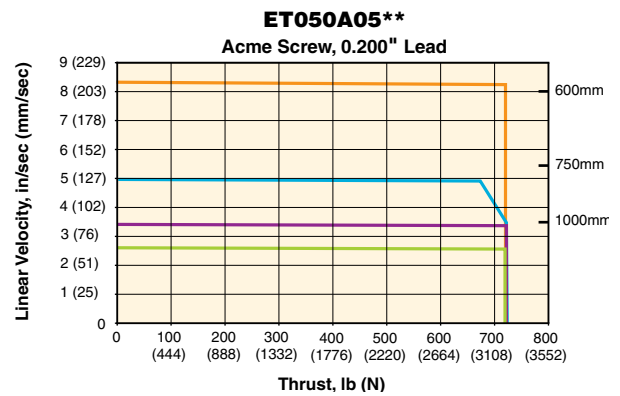
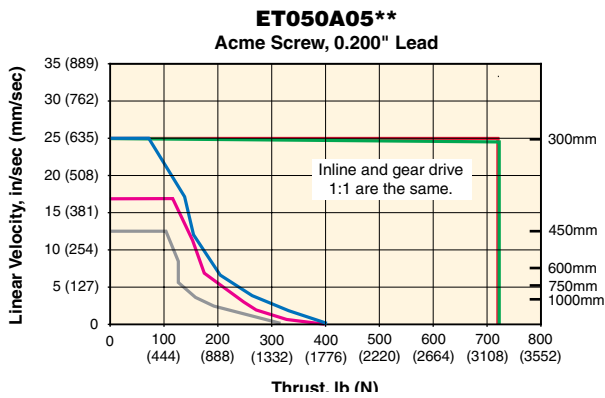
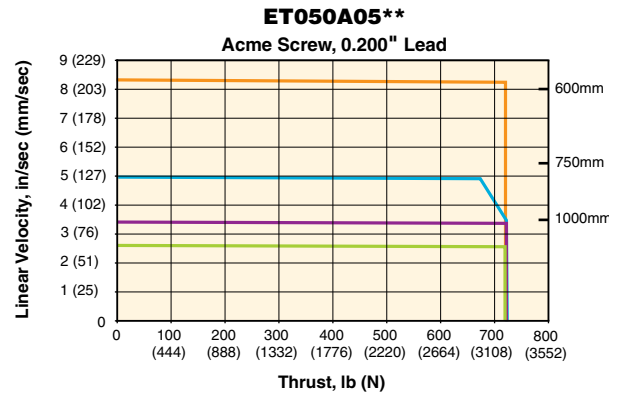
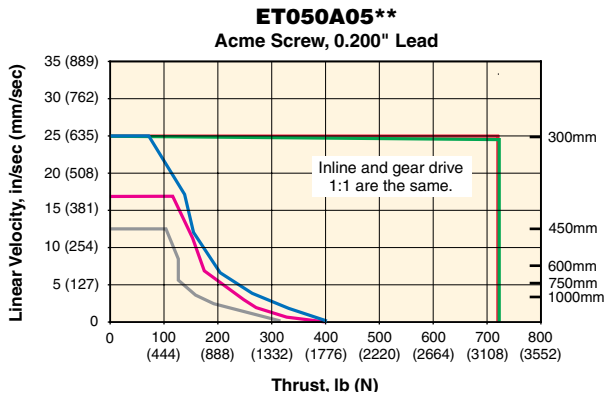

Inline Mount	Parallel Mount		
Direct Drive	Timing Belt		Gear Drive
1:1	1:1	1.5:1	2:1
			1:1

Maximum velocity is limited for longer stroke lengths. Reference stroke limits on right edge of graphs.

Parallel Mount			
Gear Drive			
3:1	5:1	7.5:1	9.5:1

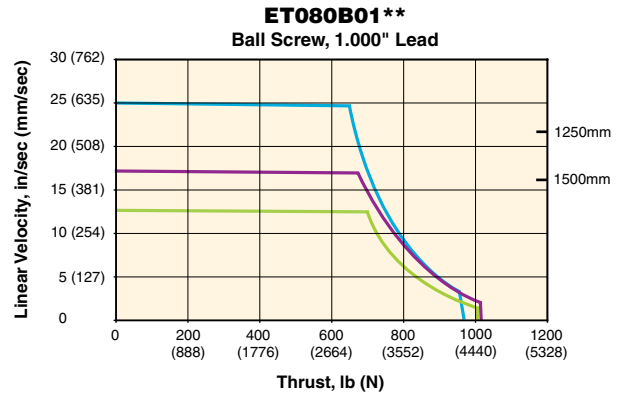
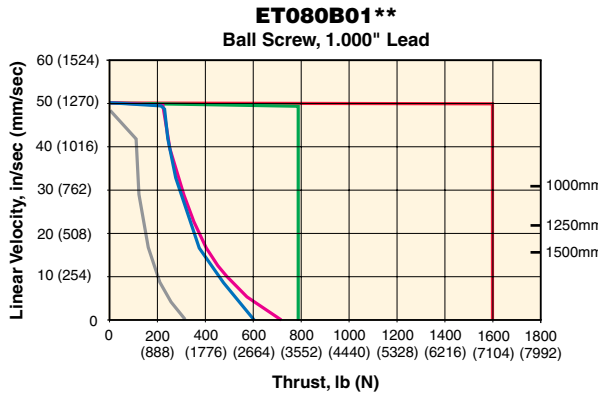
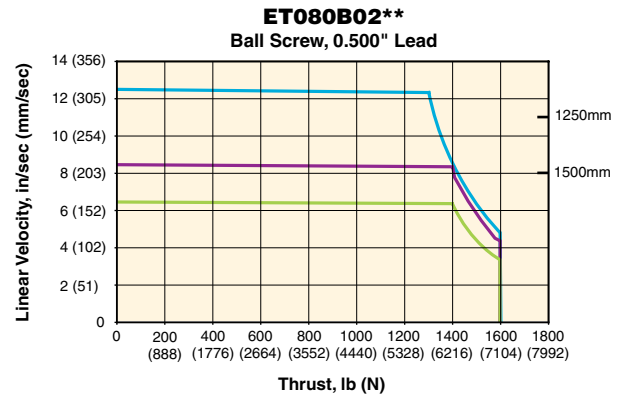
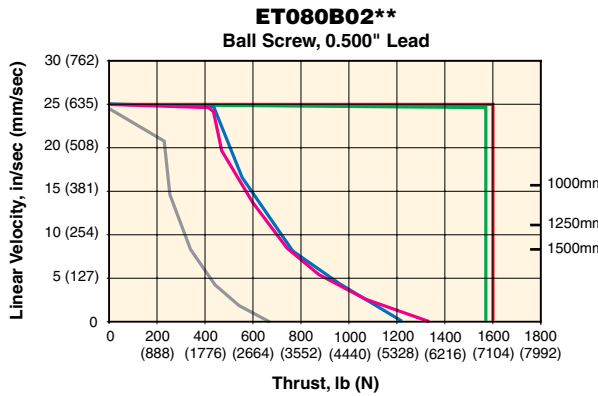
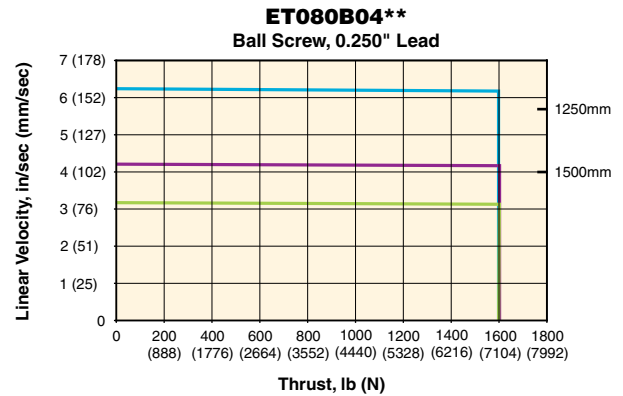
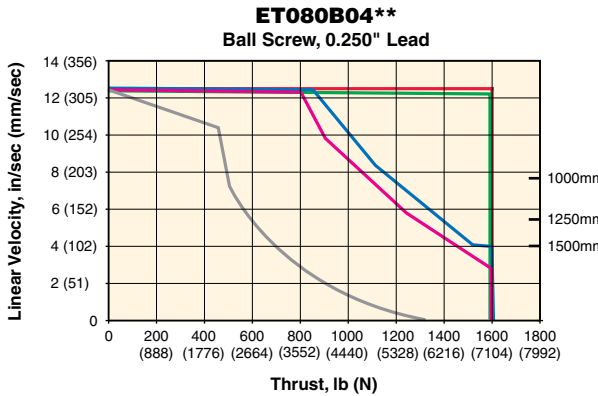
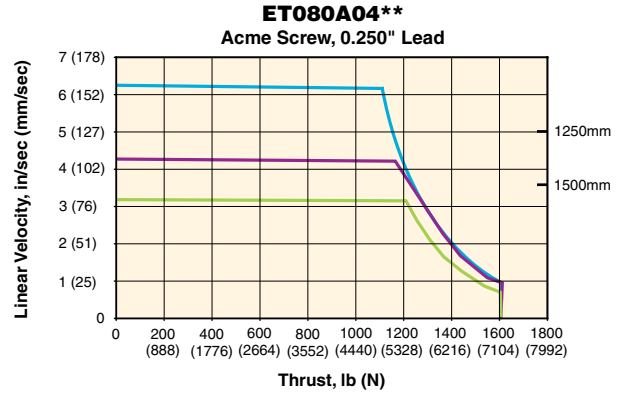
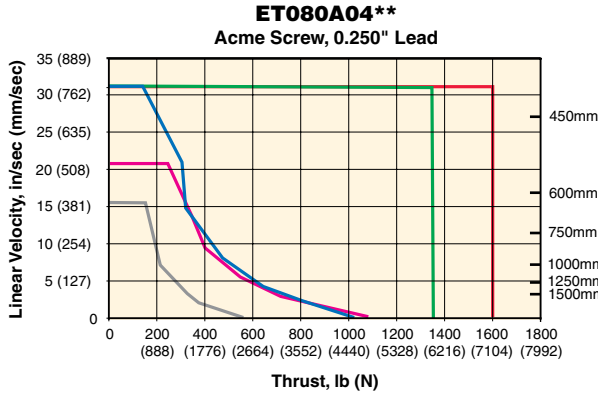

Inline Mount	Parallel Mount			
	Direct Drive	Timing Belt		Gear Drive
1:1	1:1	1.5:1	2:1	1:1

Maximum velocity is limited for longer stroke lengths. Reference stroke limits on right edge of graphs.

Parallel Mount Gear Drive		
5:1	7.5:1	10:1





# ET Performance Curves

**ET Series**

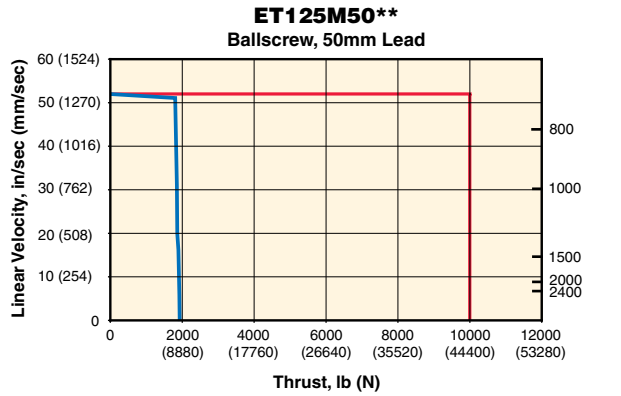
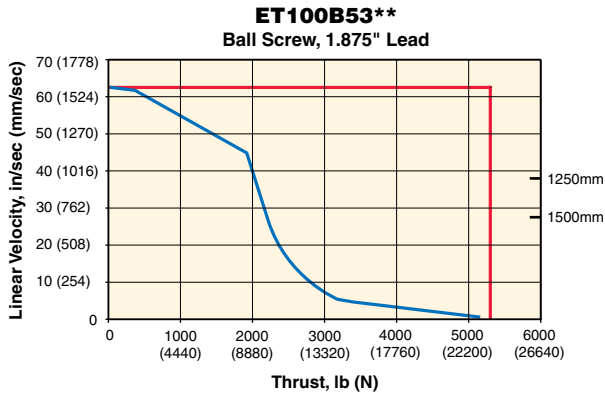
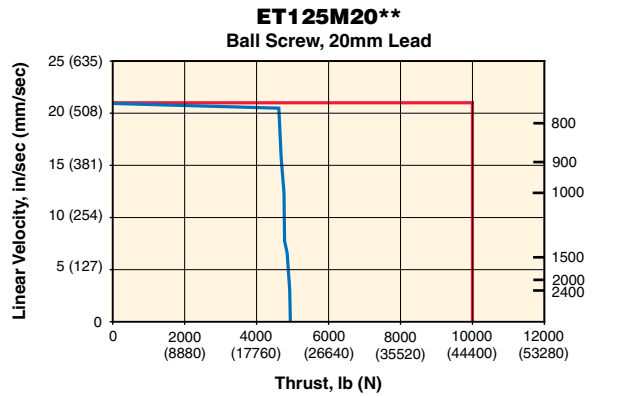
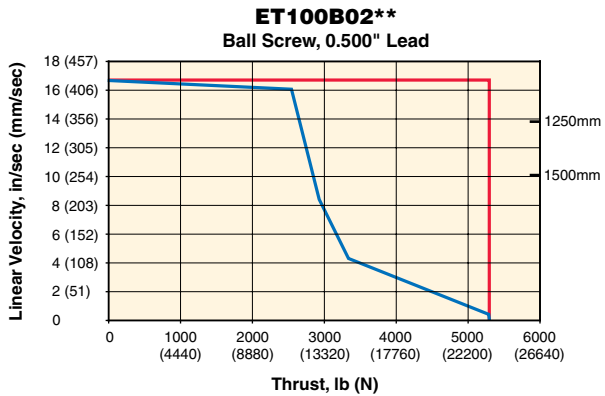
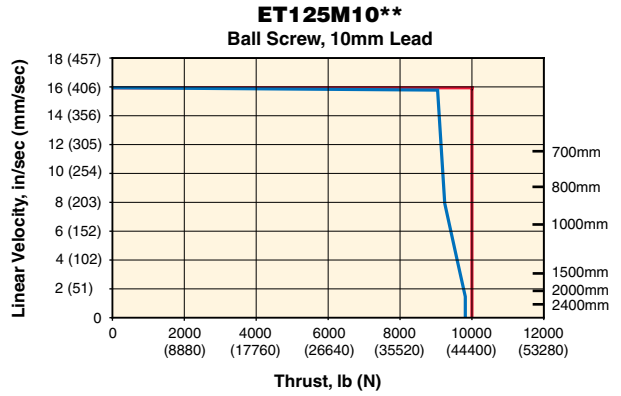
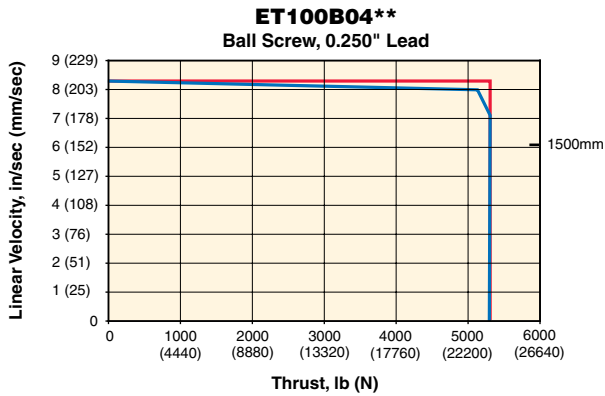
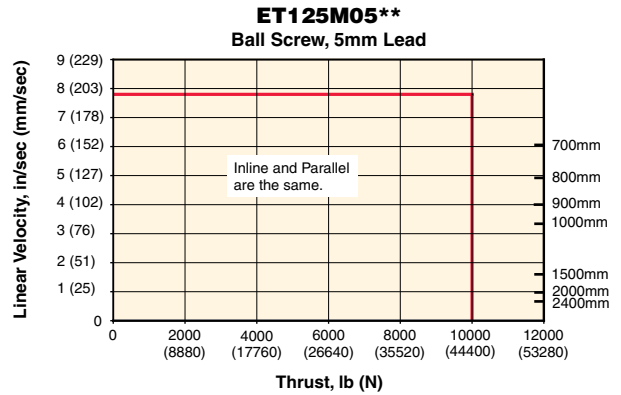
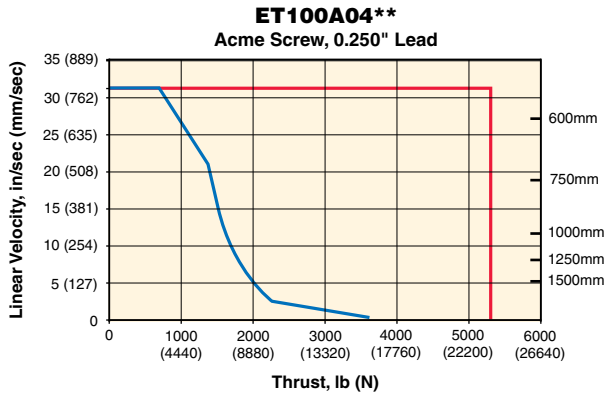

Inline Mount	Parallel Mount
Direct Drive	Timing Belt
1:1	1:1

Maximum velocity is limited for longer stroke lengths.  
Reference stroke limits on right edge of graphs.

## Rod Side Loading

The ET Series Electric Cylinder incorporates a generous rod bearing and a unique triple bearing anti-rotate assembly. However, care should be taken to limit the amount of side loading exerted on the cylinder rod. The charts below show basic load data for various stroke lengths of cylinders. Note that the load capacity increases as the available stroke increases due to greater bearing separation. For greater load capacity for a given application, a cylinder can be specified with a longer stroke, then "shortstroked" in the application.

For example, an ET32 with 450 mm of stroke has a maximum load capacity of 2 kg at full extension. An ET32 with 600 mm of available stroke, used in the same application, but only stroked to 450 mm would have a maximum side load capacity of 9.5 kg.

**Note:** If an application requires more side load than an ET cylinder allows, an optional Linear Rod Guide Module can be specified.

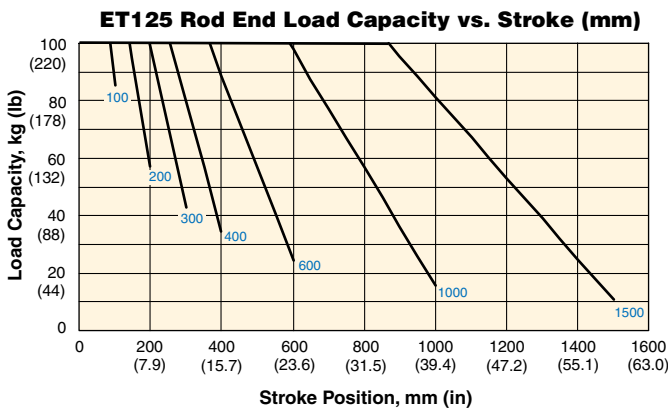
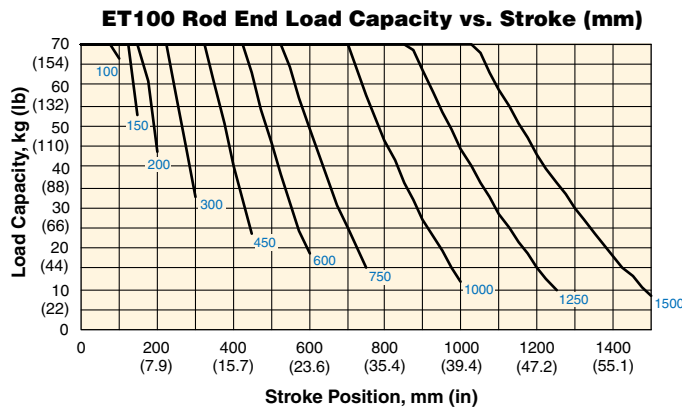
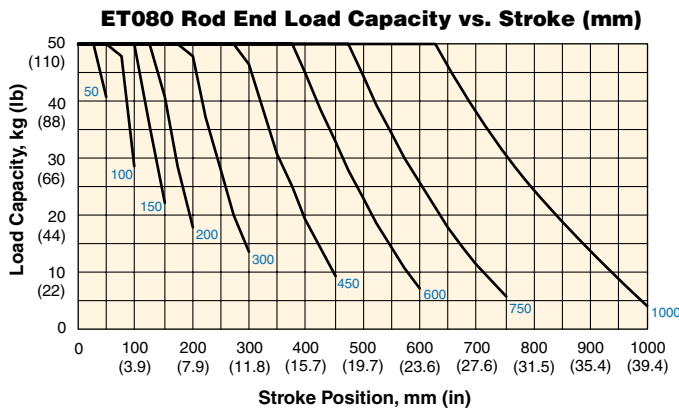
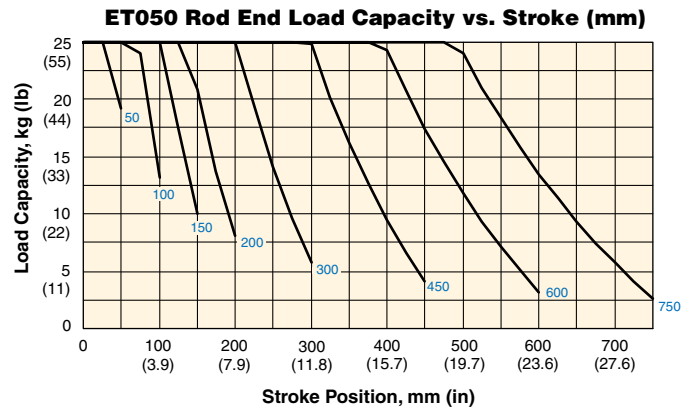
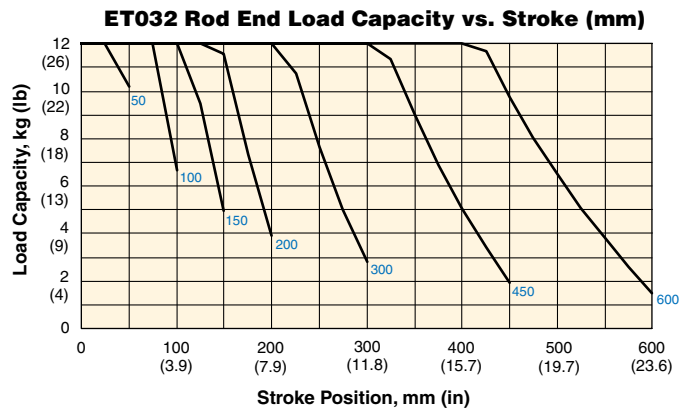

### To use charts:

1. Find the chart and curve for the chosen model number and maximum stroke (stroke length of each curve is shown in blue text).
2. Find the corresponding maximum rod load permissible at the desired stroke distance as measured from full retraction.
3. Rod side load is assumed to be perpendicularly applied directly at the rod end.

**Important:** Load data is applicable for cylinders with side load applied in plane parallel to bottom tapped holes in cylinder. This ensures internal double support rollers on screw carriage are properly loaded. (Internal rollers are located on sides of cylinder with reference to the switch groove on top of the cylinder. ET100 and ET125 have switch grooves on all 4 sides.)

## Lead Screw Life Expectancy

**Acme Screw Life:** As a result of the high friction inherent to acme screws, life expectancy is unpredictable. Load, duty cycle, speed, temp, and lubrication all affect the amount of heat generated and thread wear by the acme nut which ultimately determines the life of the mechanism. Acme screws typically have lower life expectancies than ball screws and should only be used in low duty cycle applications.

**Ball Screw Life:** Ball screws are high efficiency mechanisms that utilize a rolling friction, ball bearing nut to translate rotary motion and torque to linear motion and thrust. Life expectancy can be predicted by comparing the effective load to the screw's basic dynamic load rating. Basic dynamic load rating is the load at which a screw has a 90% probability of achieving 1,000,000 revs of life before metal fatigue develops – L10 life.

### To Use Charts:

1 Determine required life in millions of inches of travel. Life is determined by multiplying the total stroke in inches by the total number of strokes required for the designed life of the equipment.

2 Calculate the equivalent load  $L_m$ .

$$L_m = \sqrt{\frac{\%_1 (L_1)^2 + \%_2 (L_2)^2 + \%_3 (L_3)^2 + \%_n (L_n)^2}{100}}$$

Where:  $L_m$  = equivalent load  
 $L_n$  = each increment of load  
 $\%_n$  = percent of stroke at load  $L_n$

For example:

L1 = 150#    %1 = 30%  
 L2 = 225#    %2 = 45%  
 L3 = 725#    %3 = 25%

$$L_m = \sqrt{\frac{30 (150)^2 + 45 (225)^2 + 25 (725)^2}{100}}$$

$L_m = 466$  lbs

- Find the point at which load and life intersect.
- Select actuator screw combination to the right of or above the point of intersection.

For more detailed information and examples on calculating screw life, reference the ET technical manual.

**Life Expectancy (inch)  
ETB32 - ETB100**

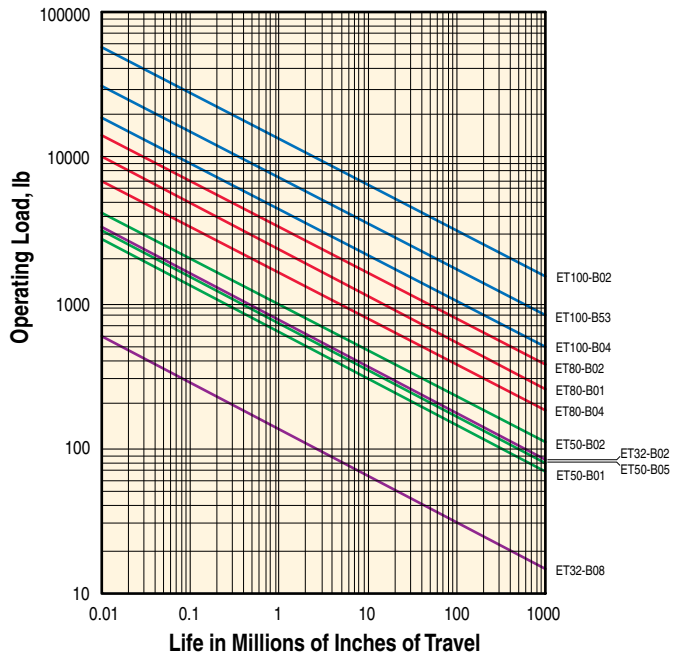

**Life Expectancy (inch)  
ETB125**

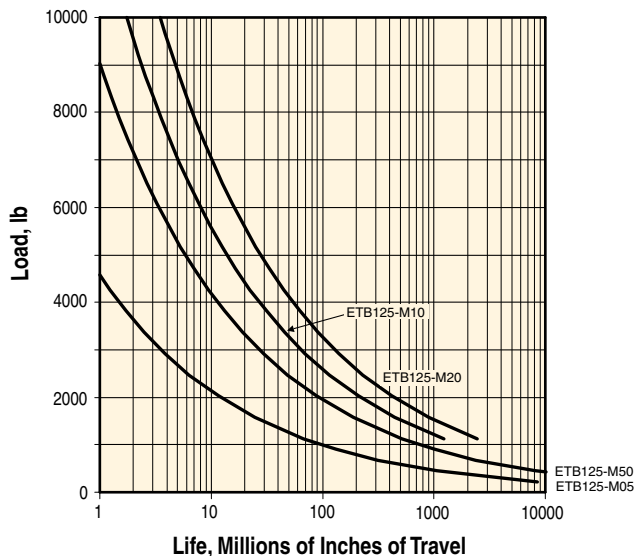

## Linear Rod Guide Module

Rod End Code R

Some applications may require guided rod movement or may experience side loads exerted on the cylinder rod. The Linear Rod Guide Module is a simple, bolt-on accessory that will support significant side loads and extend the life of the cylinder rod bearing.

### Notes:

- 1) Please consider switch groove mounting orientation when using linear rod guide module and parallel style motor mounting.
- 2) Not compatible with B, G, J, or N mounting options.
- 3) Not available with ET125 units.

### Features

- Anti-rotation is achieved by two stainless steel guide rods. The linear rod is attached to the end plate by a self-aligning coupling.
- Four linear ball bearings running on fixed guide rods provide accuracy, stability and rigidity.
- The units provide high resistance to torque loading and greatly increase cylinder side load bearing capacity.
- The cast aluminum body is a compact and light weight design and provides mounting in vertical or horizontal positions. The front flange plate incorporates several threaded and drilled holes for easy connection to customer tooling.

### Ordering Information

Cylinder	Rod Guide Part Number
ET032	32-2800R-****
ET050	50-2800R-****
ET080	80-2800R-****
ET100	100-2800R-****

\*\*\*\* = stroke in mm, i.e. 50-2800R-0200 for 200mm stroke length. Specify same stroke as ordered on the matching ET cylinder.

### NOTE:

To order Linear Rod Guide Module mounted to cylinder, specify "R" for Cylinder Rod End in Model Code.



### Permissible Torque

Use the following formula to calculate the moment loading of the rod guide.

$$C(\text{lb-in}) = F(\text{lb}) \times L(\text{in})$$

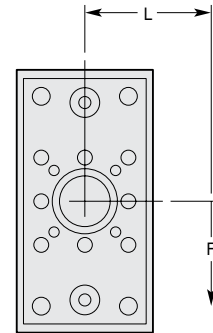

### Linear Guide Module Torque Capacity

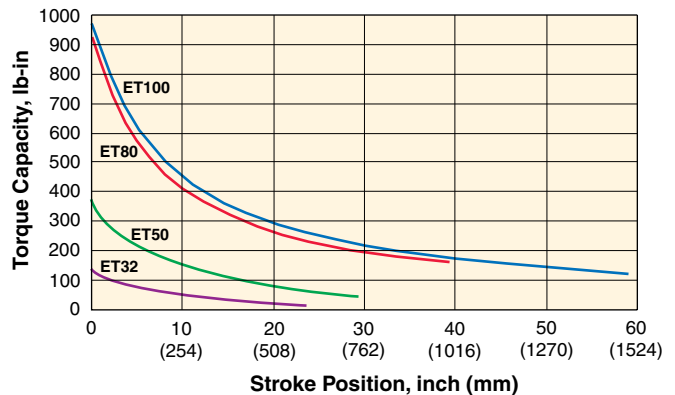

### To use chart:

1. Vertical axis indicates maximum torque capacity for specified conditions.
2. For greater torque capacity, either reduce stroke distance or use larger size actuator.

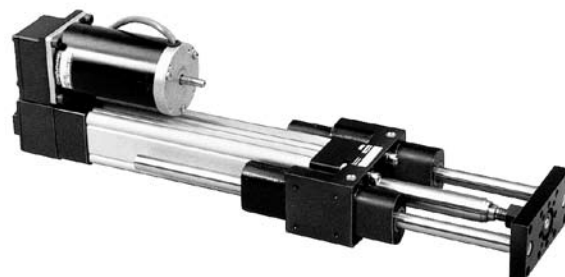

Linear Rod Guide Module  
Attached to an ET032 Cylinder

## Linear Rod Guide Module

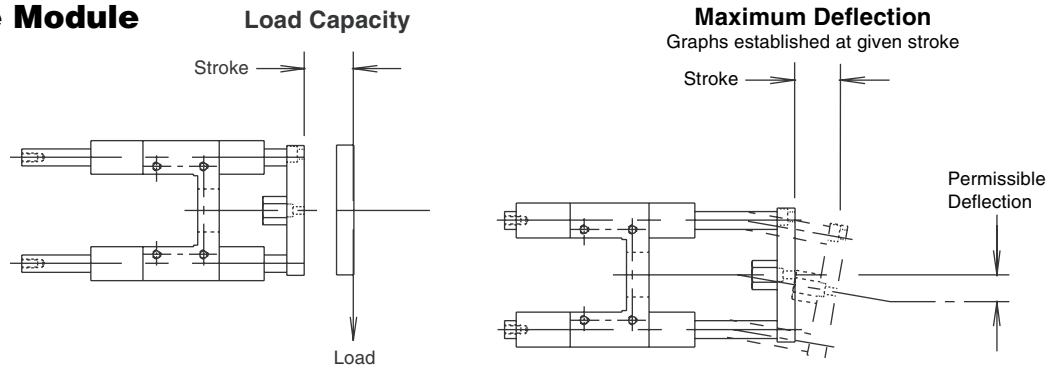

The linear rod guide module load and deflection ratings are in the charts below. All load capacities are based on one million meters of travel. To use charts:

1. For given size module, determine permissible deflection for application, based on stroke distance.
2. Maximum load capacity is indicated by upper curve.
3. Deflections are shown on lower curves.

**ET32 Rod Guide Module**  
Load Capacity vs Stroke Position

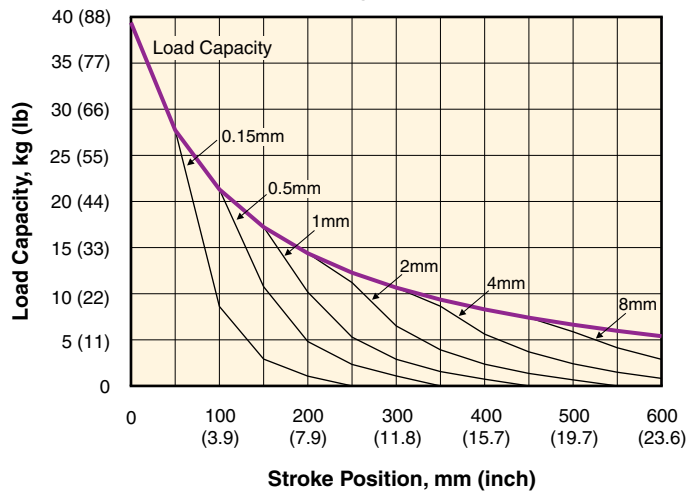

**ET50 Rod Guide Module**  
Load Capacity vs Stroke Position

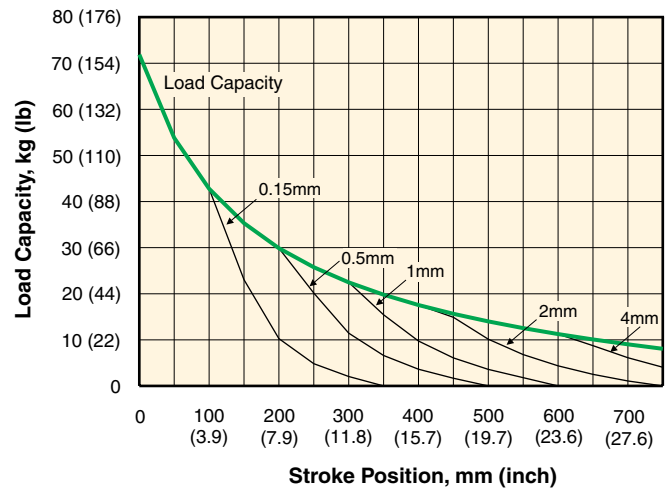

**ET80 Rod Guide Module**  
Load Capacity vs Stroke Position

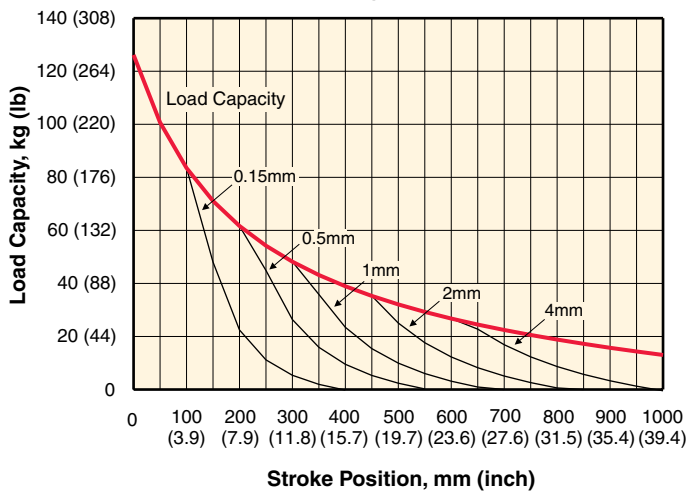

**ET100 Rod Guide Module**  
Load Capacity vs Stroke Position

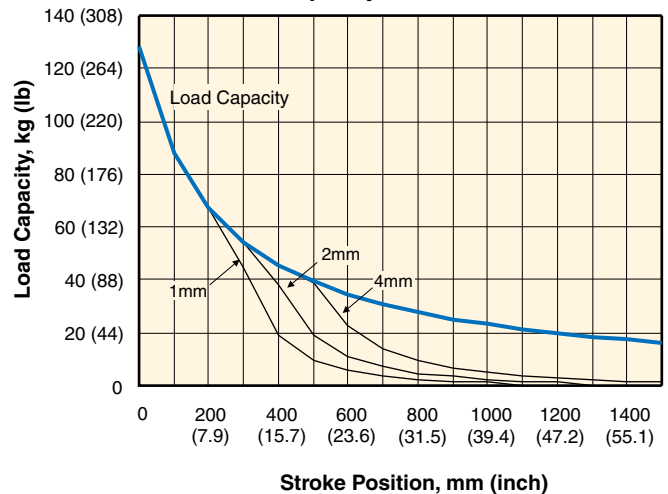

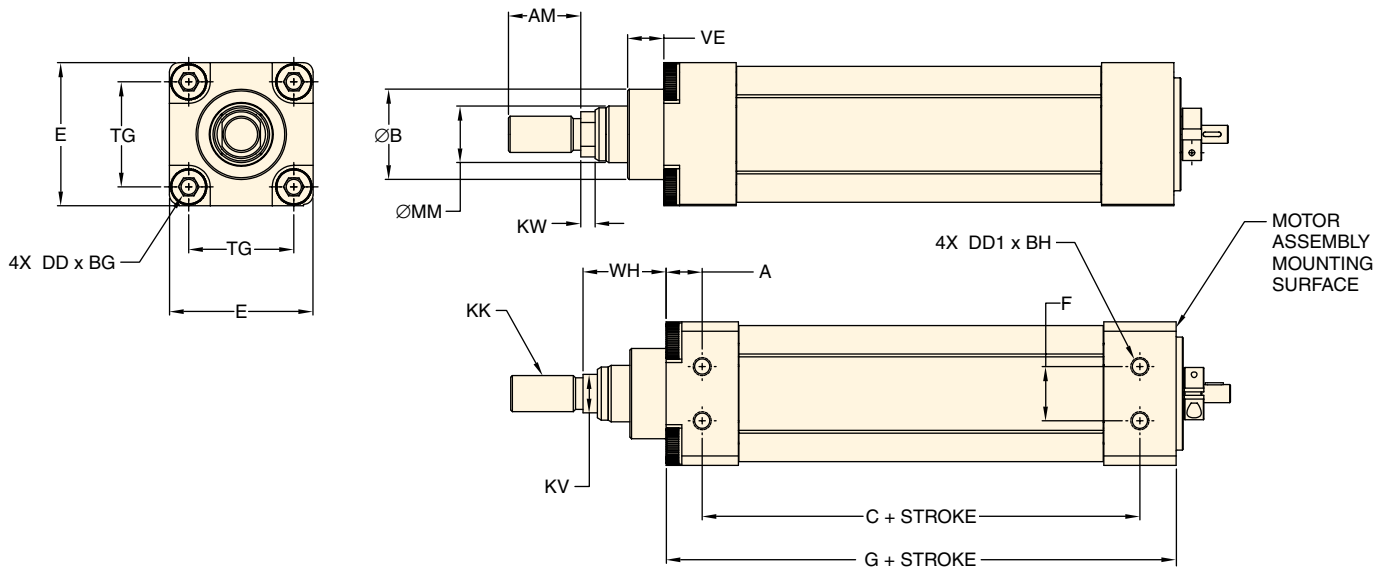

## Basic Dimensions

Model	A	AM	ØB	BG	BH	DD	DD1	E	F	KK	KV A/F	KW	ØMM	TG	VE	WH
ET032	14.0 (0.55)	22.1 (0.87)	30.0 (1.18)	16.0 (0.63)	9.0 (0.35)	M6x1	M6x1	46.5 (1.83)	16.0 (0.63)	M10x1.25	10.0 (0.39)	4.8 (0.19)	18.0 (0.71)	32.5 (1.28)	13.0 (0.51)	25.9 (1.02)
ET050	16.0 (0.63)	32.0 (1.26)	40.0 (1.57)	16.0 (0.63)	12.7 (0.50)	M8 x1.25	M8x1.25	63.5 (2.50)	24.0 (0.94)	M16x1.5	17.0 (0.67)	6.4 (0.25)	25.0 (0.98)	46.5 (1.83)	16.0 (0.63)	37.0 (1.46)
ET080	21.0 (0.83)	40.0 (1.57)	50.0 (1.97)	16.0 (0.63)	17.5 (0.69)	M10x1.5	M10x1.5	95.2 (3.75)	30.0 (1.18)	M20x1.5	22.0 (0.87)	9.9 (0.39)	35.0 (1.38)	72.0 (2.83)	20.0 (0.79)	46.5 (1.83)
ET100	27.5 (1.08)	53.8 (2.12)	65.0 (2.56)	16.0 (0.63)	24.0 (0.94)	M10x1.5	M12x1.75	114.3 (4.50)	50.0 (1.97)	M27x2.0	27.0 (1.06)	13.0 (0.51)	50.0 (1.97)	89.0 (3.50)	20.0 (0.79)	51.1 (2.01)
ET125	37.0 (1.46)	71.5 (2.81)	90.0 (3.54)	11.0 (0.43)	24.0 (0.94)	M12x1.5	M16x2.0	140.0 (5.51)	64.0 (2.52)	M36x2.0	41.0 (1.61)	13.0 (0.51)	70.0 (2.75)	110.0 (4.33)	25.4 (1.00)	73 (2.87)

## Stroke Chart (Add Stroke Length to Dimension)

Model	Screw	C	G	SA*	X1*	GF*	XD*
ET032	B08	67.9 (2.67)	96.1 (3.78)	180.0 (7.11)	108.0 (4.25)	162.0 (6.40)	181.0 (7.11)
	B02	109.3 (4.30)	137.5 (5.41)	222.0 (8.74)	149.0 (5.87)	204.0 (8.03)	222.0 (8.74)
	A08	58.5 (2.30)	86.7 (3.41)	171.0 (6.74)	98.0 (3.88)	153.0 (6.03)	171.0 (6.74)
	A04	58.5 (2.30)	86.7 (3.41)	171.0 (6.74)	98.0 (3.88)	153.0 (6.03)	222.0
ET050	B05	93.7 (3.69)	126.0 (4.96)	229.0 (9.03)	147.0 (5.78)	206.0 (8.13)	229.0 (9.03)
	B02	93.7 (3.69)	126.0 (4.96)	229.0 (9.03)	147.0 (5.78)	206.0 (8.13)	229.0 (9.03)
	B01	93.7 (3.69)	126.0 (4.96)	229.0 (9.03)	147.0 (5.78)	206.0 (8.13)	229.0 (9.03)
	A05	75.7 (2.98)	107.9 (4.25)	211.0 (8.32)	129.0 (5.07)	188.0 (7.42)	211.0 (8.32)
	B04	126.8 (4.99)	170.3 (6.71)	308.0 (12.13)	192.0 (7.57)	277.0 (10.91)	308.0 (12.14)
ET080	B02	146.1 (5.75)	189.6 (7.47)	327.0 (12.88)	212.0 (8.33)	297.0 (11.68)	328.0 (12.90)
	B01	143.3 (5.64)	186.8 (7.36)	325.0 (12.78)	209.0 (8.22)	294.0 (11.56)	325.0 (12.79)
	A04	111.6 (4.39)	155.1 (6.11)	293.0 (11.53)	177.0 (6.97)	262.0 (10.32)	293.0 (11.54)
	B04	218.1 (8.59)	276.8 (10.90)	434.0 (17.09)	296.5 (11.67)	407.0 (16.03)	444.0 (17.48)
ET100	B02	277.5 (10.93)	336.3 (13.24)	493.0 (19.43)	356.0 (14.01)	466.0 (18.37)	504.0 (19.82)
	B53	292.5 (11.52)	351.3 (13.83)	509.0 (20.03)	371.0 (14.61)	482.0 (18.97)	519.0 (20.42)
	A04	201.3 (7.93)	260.1 (10.24)	417.0 (16.44)	280.0 (11.02)	390.0 (15.38)	427.0 (16.83)
	M05	207.0 (8.15)	461.5 (18.17)	495.0 (19.49)	316.5 (12.46)	484.8 (19.09)	550.8 (21.69)
ET125	M10	240.0 (9.45)	494.5 (19.47)	528.0 (20.79)	349.5 (13.76)	517.8 (20.39)	583.8 (22.98)
	M20	233.0 (9.17)	487.5 (19.19)	521.2 (20.52)	342.5 (13.48)	510.8 (20.11)	576.8 (22.71)
	M50	260.0 (10.24)	514.5 (20.26)	548.1 (21.58)	369.5 (14.55)	537.8 (21.17)	603.8 (23.77)

\* Dimensions shown on mounting options pages.

## Motor Mounting

### Inline (Direct Drive)

Dimensions L1 and L2 are dependent on drive motor dimensions. Consult factory.

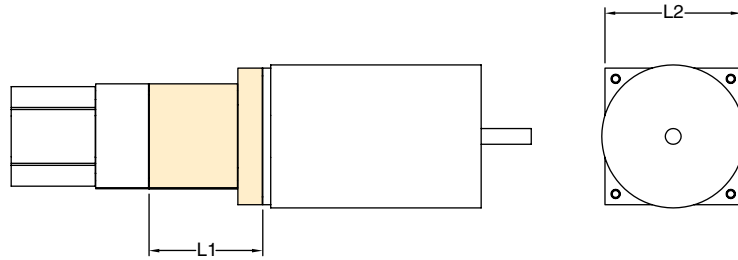

### Parallel (Timing Belt)

#### Common Dimensions

Size	ØBB	P1	P3	P4	VD	E
32	30.0 (1.18)	106.4 (4.19)	36.4 (1.43)	14.0 (0.55)	4.0 (0.16)	46.5 (1.83)
50	40.0 (1.57)	139.5 (5.49)	39.3 (1.55)	14.4 (0.57)	4.0 (0.16)	63.5 (2.50)
80	45.0 (1.77)	191.3 (7.53)	55.6 (2.19)	21.1 (0.83)	5.0 (0.20)	95.2 (3.75)
100	55.0 (2.17)	254.0 (10.0)	75.5 (2.97)	31.0 (1.22)	4.0 (0.16)	114.3 (4.50)
125	90.0 (3.54)	334.5 (13.17)	127.1 (5.00)	40.0 (1.57)	7.0 (0.28)	139.7 (5.50)

Dimensions P5 and P6 are dependent on drive motor dimensions. Consult factory.

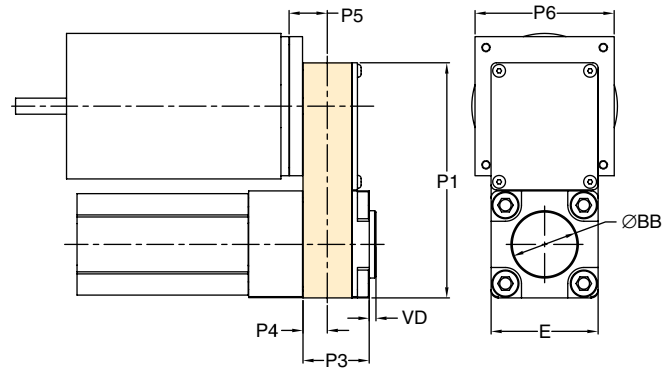

### Parallel (Gear Drive)

#### Common Dimensions

Size	ØBB	G1	G3	G4	VD	E
32	30.0 (1.18)	125.5 (4.94)	53.3 (2.10)	24.3 (0.96)	4.0 (0.16)	46.5 (1.83)
50	40.0 (1.57)	157.5 (6.20)	77.5 (3.05)	31.6 (1.24)	4.0 (0.16)	63.5 (2.50)
80	45.0 (1.77)	207.2 (8.16)	76.0 (2.99)	38.0 (1.50)	5.0 (0.20)	95.2 (3.75)

Dimensions G5 and G6 are dependent on drive motor dimensions. Consult factory.

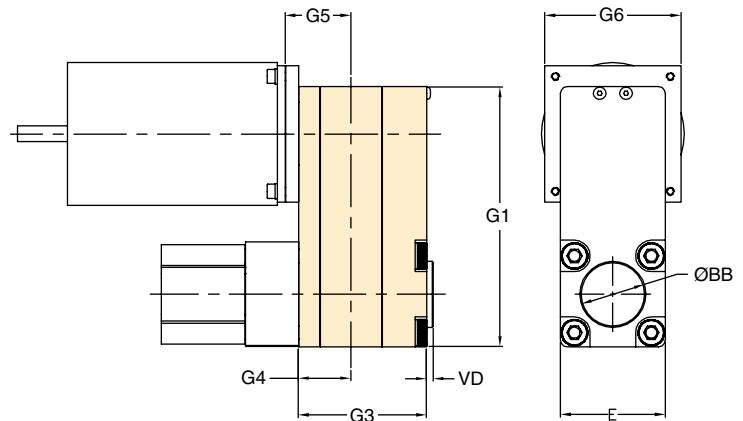

Visit [www.parker.com/actuator](http://www.parker.com/actuator)  
for 3D models.



## Foot Mounting (MS1)

Cylinder Mounting Code B

*Parallel Motor Mounting only*

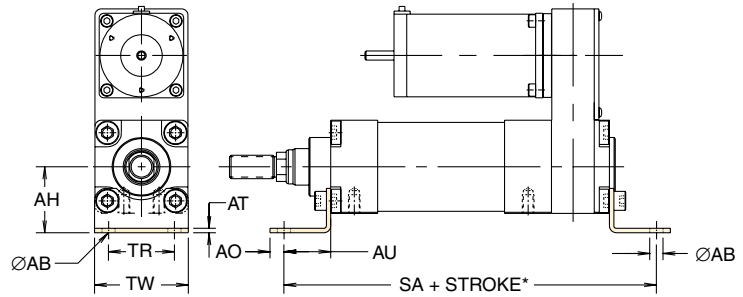

Cylinder	AH	AT	TR CRS	ØAB	AO	AU	TW
ET032	32.0 (1.26)	3.0 (0.12)	31.7/32.2 (1.25/1.27)	7.0 (0.28)	7.2 (0.28)	24.0 (0.94)	46.5 (1.83)
ET050	45.0 (1.77)	3.0 (0.12)	44.7/45.3 (1.76/1.78)	9.0 (0.35)	9.5 (0.37)	32.0 (1.26)	64.0 (2.52)
ET080	63.0 (2.48)	4.0 (0.16)	62.7/63.3 (2.47/2.49)	12.0 (0.47)	16.5 (0.65)	41.0 (1.61)	96.0 (3.78)
ET100	71.0 (2.80)	4.0 (0.16)	74.7/75.3 (2.94/2.96)	14.0 (0.55)	19.0 (0.75)	41.0 (1.61)	113.0 (4.45)
ET125	90.0 (3.54)	8.3 (0.33)	90.4 (3.56)	17.0 (0.67)	25.0 (0.98)	45.0 (1.77)	140.0 (5.51)

## Side Lug Mounting

Cylinder Mounting Code G

*Not available with Q or M motor mounting.*

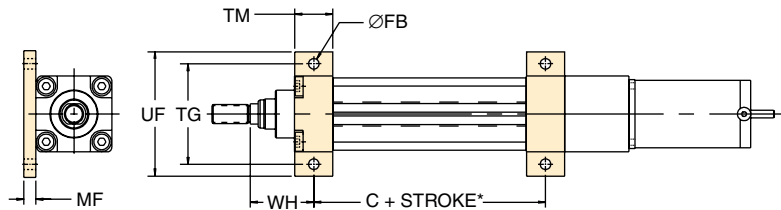

Cylinder	TG	UF	FB	TM	MF	WH
ET032	62.0 (2.44)	78.0 (3.07)	6.7 (0.266)	25.4 (1.00)	8.0 (0.315)	40.0 (1.57)
ET050	84.0 (3.31)	104.0 (4.09)	8.7 (0.344)	31.8 (1.25)	10.0 (0.394)	53.0 (2.09)
ET080	120.0 (4.72)	144.0 (5.65)	11.0 (0.433)	38.1 (1.50)	12.0 (0.472)	67.0 (2.64)
ET100	150.0 (5.91)	185.0 (7.28)	12.8 (0.50)	57.2 (2.25)	12.0 (0.472)	78.0 (3.09)
ET125	175.0 (6.89)	210.0 (8.27)	17.0 (0.67)	69.9 (2.75)	20.0 (0.79)	110.0 (4.33)

## Trunnion Mount (MT4)

Cylinder Mounting Code D

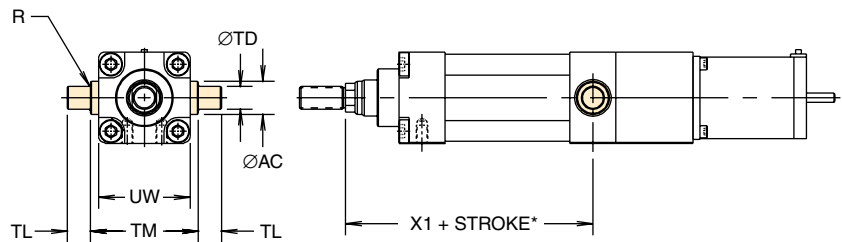

Cylinder	UW	ØTD	R	TL	TM	ØAC
ET032	46.5 (1.83)	12.0 (0.47)	0.8 (0.03)	12.0 (0.47)	50.0 (1.97)	18.0 (0.71)
ET050	63.5 (2.50)	16.0 (0.63)	0.8 (0.03)	16.0 (0.63)	75.0 (2.95)	25.0 (0.98)
ET080	95.3 (3.75)	20.0 (0.79)	0.8 (0.03)	20.0 (0.79)	110.0 (4.33)	30.0 (1.18)
ET100	114.3 (4.50)	25.0 (0.98)	1.6 (0.06)	25.0 (0.98)	132.0 (5.20)	40.0 (1.57)
ET125	139.7 (5.50)	32.0 (1.26)	2.0 (0.08)	32.0 (1.26)	149.7 (5.89)	45.0 (1.77)

\* See stroke chart on page 14.

## Front & Rear Flange Mounting (MF1 & MF2)

Cylinder Mounting Codes J, H, N

*Inline Mounting not available with Rear Flange*

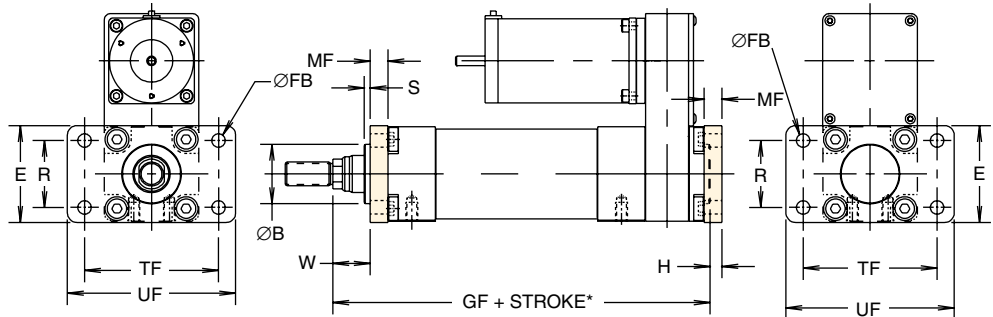

Cylinder	UF	E	TF	ØFB	R	W	MF	H	ØB	S
ET032	80.0 (3.15)	47.0 (1.85)	63.7/64.3 (2.51/2.53)	7.0/7.2 (0.27/0.28)	31.7/32.2 (1.25/1.27)	16.0 (0.63)	9.88/10.12 (0.39/0.40)	6.0 (0.24)	30.0 (1.18)	3.0 (0.12)
ET050	113.0 (4.45)	65.0 (2.56)	89.6/90.4 (3.53/3.56)	9.0/9.2 (0.35/0.39)	44.7/45.3 (1.76/1.78)	25.0 (0.98)	11.88/12.12 (0.47/0.48)	8.0 (0.32)	40.0 (1.58)	4.0 (0.16)
ET080	153.0 (6.02)	97.0 (3.82)	125.5/126.5 (4.94/4.98)	12.0/12.2 (0.47/0.48)	62.7/63.3 (2.47/2.49)	30.0 (1.18)	15.88/16.12 (0.62/0.63)	11.0 (0.43)	50.0 (1.97)	4.0 (0.16)
ET100	186.0 (7.32)	111.0 (4.37)	149.5/150.5 (5.89/5.93)	14.0/14.2 (0.55/0.56)	74.7/75.3 (2.94/2.96)	35.0 (1.38)	15.88/16.12 (0.62/0.63)	12.0 (0.47)	65.0 (2.56)	4.0 (0.16)
ET125	220.0 (8.68)	139.5 (5.49)	179.9/180.1 (7.08/7.09)	16.9/17.1 (0.66/0.67)	89.9/90.1 (3.54/3.55)	53.0 (2.09)	19.9/20.1 (0.78/0.79)	13.0 (0.51)	90.0 (3.54)	5.4 (0.21)

## Rear Eye Mounting (MP4)

Cylinder Mounting Code E

*Parallel Motor Mounting only*

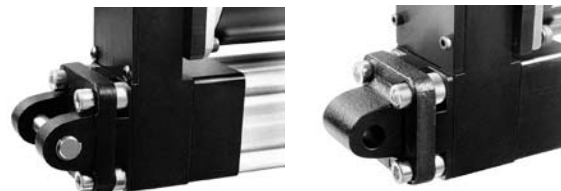

## Rear Clevis (MP2-R)

Cylinder Mounting Code C

*Parallel Motor Mounting only*

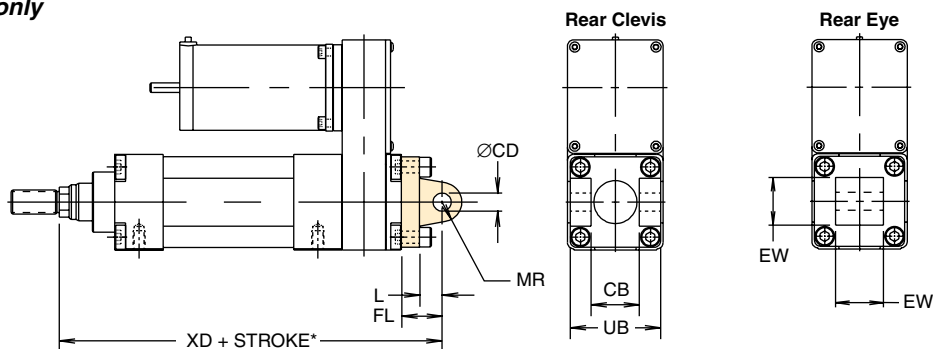

Cylinder	EW	øCD	MR	FL	L	CB Rear Only	UB
ET032	25.3/25.8 (0.99/1.02)	10.0 (0.39)	10.0 (0.39)	22.0 (0.87)	12.0 (0.47)	26.0 (1.02)	44.4/45.0 (1.75/1.77)
ET050	31.3/31.8 (1.23/1.25)	12.0 (0.47)	13.0 (0.51)	27.0 (1.06)	15.0 (0.59)	32.0 (1.26)	59.2/60.0 (2.33/2.36)
ET080	49.7/49.8 (1.96/1.96)	16.0 (0.63)	20.0 (0.79)	36.0 (1.42)	20.0 (0.79)	50.0 (1.97)	89.4/90.0 (3.52/3.54)
ET100	59.3/59.8 (2.33/2.35)	20.0 (0.79)	22.0 (0.87)	41.0 (1.61)	25.0 (0.98)	60.0 (2.36)	109.0/110.0 (4.29/4.33)
ET125	29.6/30.0 (1.17/1.18)	20.0 (0.79)	29.0 (1.14)	73.0 (2.87)	32.0 (1.26)	30.0 (1.18)	60.0 (2.36)

\* See stroke chart on page 14.

# ET Rod End Options



## Male

Rod End Code M (Metric)

Rod End Code K (inch)

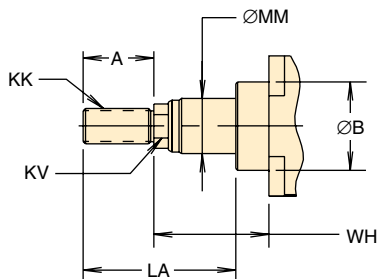

Cylinder	A	ØB	KK (Metric)	KK (Inch)	KV	LA	ØMM	WH
ET032	22.0 (0.87)	30.0 (1.18)	M10 x 1.25	7/16-20	10.0 (0.39)	35.0 (1.38)	18.0 (0.71)	26.0 (1.02)
ET050	32.0 (1.26)	40.0 (1.57)	M16 x 1.5	5/8-18	17.0 (0.67)	53.0 (2.09)	25.0 (0.98)	37.0 (1.46)
ET080	40.0 (1.57)	50.0 (1.97)	M20 x 1.5	3/4-16	22.0 (0.87)	66.0 (2.60)	35.0 (1.38)	46.0 (1.81)
ET100	54.0 (2.13)	65.0 (2.56)	M27 x 2.0	1-14	27.0 (1.06)	85.0 (3.35)	50.0 (1.97)	51.0 (2.01)
ET125	71.5 (2.81)	90.0 (3.54)	M36 x 2.0	1 3/8-12	41.0 (1.61)	119.1 (4.69)	70.0 (2.76)	73.0 (2.87)

## Female

Rod End Code F (Metric)

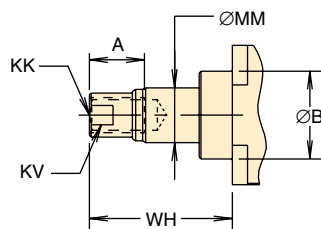

Cylinder	A	ØB	KK	KV	ØMM	WH
ET032	15.0 (0.59)	30.0 (1.18)	M10 x 1.25	12.0 (0.47)	18.0 (0.71)	32.0 (1.26)
ET050	25.0 (0.98)	40.0 (1.57)	M16 x 1.5	20.0 (0.79)	25.0 (0.98)	50.0 (1.96)
ET080	30.0 (1.18)	50.0 (1.97)	M20 x 1.5	26.0 (1.02)	35.0 (1.38)	59.0 (2.32)
ET100	40.0 (1.57)	65.0 (2.56)	M27 x 2	37.0 (1.46)	50.0 (1.97)	73.0 (2.87)
ET125	50.3 (1.98)	90.0 (3.54)	M36 x 2.0	55.0 (2.17)	70.0 (2.76)	104.5 (4.11)

## Rod Clevis

Rod End Code C

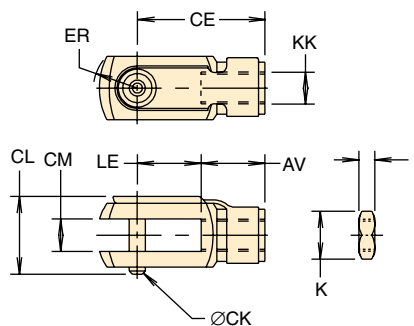

Cylinder	KK	CL	CM	LE	CE	AV	ER	ØCK	K (A/F)	L
ET032	M10 x 1.25	26.0 (1.02)	10.2 +0.13, -0.05	20.0 (0.78)	40.0 (1.57)	20.0 (0.78)	14.0 (0.55)	10.0 +0, -0.1	17.0 (0.67)	6.0 (0.24)
ET050	M16 x 1.5	39.0 (1.54)	16.2 +0.13, -0.05	32.0 (1.26)	64.0 (2.52)	32.0 (1.26)	22.0 (0.87)	16.0 +0, -0.2	24.0 (0.94)	8.0 (0.31)
ET080	M20 x 1.5	52.5 (2.07)	20.1 +0.02, -0.0	40.0 (1.57)	80.0 (3.15)	40.0 (1.57)	30.0 (1.18)	20.0 +0, -0.2	30.0 (1.18)	9.0 (0.35)
ET100	M27 x 2.0	63.0 (2.48)	30.0 +0.6, -0.2	54.0 (2.13)	110.0 (4.33)	56.0 (2.20)	35.0 (1.38)	30.0 +0, -0.2	41.0 (1.61)	12.0 (0.47)
ET125	M36 x 2.0	70.0 (2.76)	35.0 (1.38)	72.0 (2.83)	144.0 (5.67)	72.0 (2.83)	57.0 (2.24)	35.0 (1.38)	55.0 (2.17)	18.0 (0.71)

## Rod End Options Spherical Rod Eye

Rod End Code S

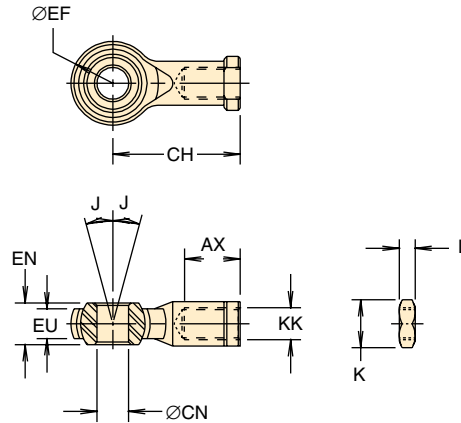

Cylinder	ØCN	EN	EU	AX	CH	ØEF	KK	J°	K (A/F)	L
ET032	10.0 (0.39)	14.0 (0.55)	10.5 (0.41)	20.0 (0.79)	43.0 (1.69)	29.0 (1.14)	M10 x 1.25	13	17.0 (0.66)	6.0 (0.24)
ET050	16.0 (0.63)	21.0 (0.83)	15.0 (0.59)	28.0 (1.10)	64.0 (2.52)	42.0 (1.65)	M16 x 1.5	15	24.0 (0.94)	8.0 (0.31)
ET080	20.0 (0.79)	25.0 (0.98)	18.0 (0.71)	33.0 (1.30)	77.0 (3.03)	50.0 (1.97)	M20 x 1.5	14	30.0 (1.18)	9.0 (0.35)
ET100	30.0 (1.18)	37.0 (1.46)	25.0 (0.98)	51.0 (2.00)	110.0 (4.33)	70.0 (2.76)	M27 x 2.0	15	41.0 (1.61)	12.0 (0.47)
ET125	35.0 (1.38)	43.0 (1.69)	28.0 (1.10)	56.0 (2.20)	125.0 (4.92)	80.0 (3.15)	M36 x 2.0	16	55.0 (2.17)	18.0 (0.71)

## Linear Rod Guide Module

Rod End Code R

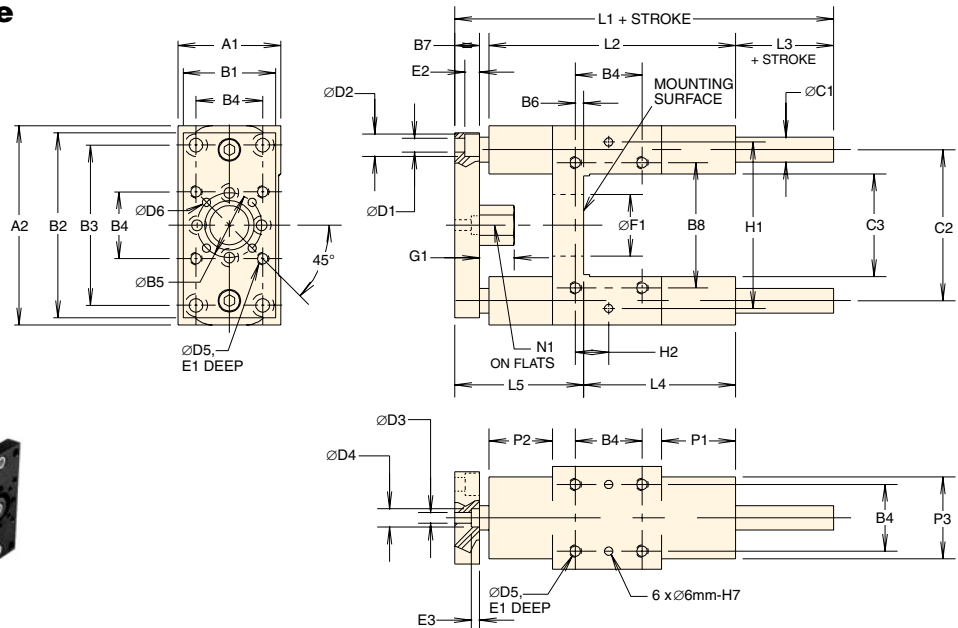

Cylinder	A1	A2	B1	B2	B3	B4	ØB5	B6	B7	B8	ØC1	C2	C3	ØD1	ØD2	ØD3	ØD4	ØD5	ØD6
ET032	50	97	44.4	92	78.0	32.5	31.5	4	12	61	12.0	73.5	50	6.6	11	5.2	9	M6x1.00	4
ET050	70	137	63	132	100	46.5	50	19	15	85	20	103.5	70	9	14	6.4	11	M8x1.25	4
ET080	105	189	101.6	180	130	72	76	21	20	130	25	147	105	11	17	8.4	14	M10x1.50	6
ET100	130	213	120	200	150	89	76	24.5	20	150	25	171.5	130	11	17	8.4	14	M10x1.50	6

Cylinder	E1	E2	E3	ØF1	G1	H1	H2	L1	L2	L3	L4	L5	N1	P1	P2	P3	Basic Unit, kg (lb)	Extra per 100mm Stroke, kg (lb)
ET032	12	7	4	30	17	81	16	152	120	17	71	64	17	36	31.0	40	0.97 (2.14)	0.175 (0.39)
ET050	16	9	9	40	27	119	23	193	150	25	79	89	24	42	44	50	2.56 (5.64)	0.495 (1.09)
ET080	20	11	5	45	32	166	36	253	200	30	113	110	30	50	52	70	6.53 (14.4)	0.770 (1.70)
ET100	20	11	5	55	55	190	45	273	220	30	128	138	30	49	51	70	8.76 (19.32)	0.770 (1.70)

## Linear Alignment Coupler

Order separately from table below.

- Prevents binding and reduces side loads induced by misalignment
- Increases cylinder life by reducing wear on rod and screw bearings
- Simplifies cylinder installation and reduces assembly costs
- Metric and Imperial thread type available

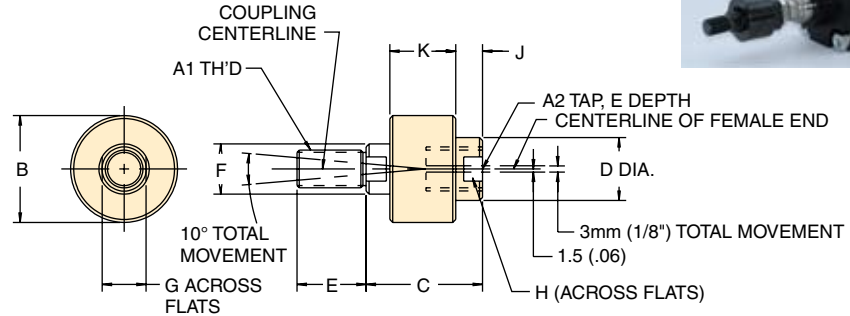

Model	Coupler Part No.	A1 Thd.	A2 Thd.	B	C	D	E	F	G	H	J	K
ET032	LC32-1010	M10 x 1.25	M10 x 1.25	40.0 (1.56)	51.0 (2.00)	19.0 (0.75)	19.0 (0.75)	16.0 (0.63)	13.0 (0.50)	16.0 (0.63)	13.0 (0.50)	26.0 (1.03)
	1347570044	7/16-20	7/16-20									
ET050	LC50-1616	M16 x 1.50	M16 x 1.50	54.0 (2.13)	59.0 (2.31)	32.0 (1.25)	29.0 (1.13)	25.0 (1.00)	22.0 (0.88)	29.0 (1.13)	14.0 (0.53)	33.0 (1.31)
	1347570063	5/8-18	5/8-18									
ET080	LC80-2020	M20 x 1.50	M20 x 1.50	54.0 (2.13)	59.0 (2.31)	32.0 (1.25)	29.0 (1.13)	25.0 (1.00)	22.0 (0.88)	29.0 (1.13)	14.0 (0.53)	33.0 (1.31)
	1347570075	3/4-16	3/4-16									
ET100	LC100-2727	M27 x 2.0	M27 x 2.0	89.0 (3.50)	102.0 (4.00)	51.0 (2.00)	51.0 (2.00)	38.0 (1.50)	32.0 (1.25)	43.0 (1.69)	19.0 (0.75)	64.0 (2.50)
	1337390100	1-14	1-14									
ET125	LC125-3636	M36 x 2.0	M36 x 2.0	101.6 (4.0)	111.3 (4.38)	57.2 (2.25)	57.2 (2.25)	44.5 (1.75)	38.1 (1.50)	49.3 (1.94)	22.1 (0.87)	69.9 (2.75)
	1337390125AAD	1 3/8-12	1 3/8-12									

## Brake

A brake option is available on ET electric cylinders to prevent back driving of the cylinder rod when power is removed from the motor. The brake is a spring loaded, friction disc type that requires a separate power signal (24 VDC or 115 VAC) to the solenoid that releases the brake.

The brake option attaches directly to the rear of the ball or Acme screw, preventing movement of the cylinder rod for static conditions. Options which mount to the rear of the actuator are not available with the brake option.

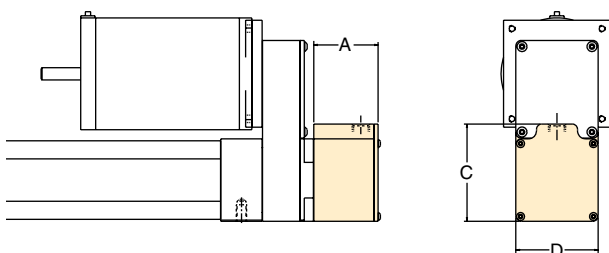

Actuator	Screw	Lead (in)	Holding Force N (lb)
ET032	B02	0.500	600 N (135 lb)
	B08	0.125	600 N (135 lb)
	A04	0.250	600 N (135 lb)
	A08	0.125	600 N (135 lb)
ET050	B01	1.000	735 N (165 lb)
	B02	0.500	1560 N (350 lb)
	B05	0.200	3200 N (720 lb)
ET080	A05	0.200	3200 N (720 lb)
	B01	1.000	2560 N (575 lb)
	B02	0.500	5120 N (1150 lb)
ET100	B04	0.250	7120 N (1600 lb)
	A04	0.250	7120 N (1600 lb)
	B53	1.875	2670 N (600 lb)
ET100	B02	0.500	10350 N (2325 lb)
	B04	0.250	20700 N (4650 lb)
	A04	0.250	20700 N (4650 lb)

Cylinder	A	C	D
ET032	43.4 (1.71)	50.0 (1.97)	63.5 (2.50)
ET050	55.0 (2.18)	75.0 (2.95)	63.5 (2.50)
ET080	76.0 (3.00)	95.3 (3.75)	95.3 (3.75)
ET100***	82.6 (3.25)	136.7 (5.38)	127.0 (5.00)

## Preloaded Ball Screws

The introduction of a second ball nut, preloaded against the first ball nut, eliminates backlash in the ball screw. This option is available on all ball screw-actuator combinations. *This option will increase overall actuator length.*

## Precision Ground Ball Screws

Substituting a precision ground ball screw for the standard rolled ball screw improves lead error and overall system accuracy.

## Bellows (Rod Boot) Option

Protect the stainless steel thrust tube with a hypalon/polyester rod boot, or bellows. The bellows option is tied on both ends and shields the thrust tube from splatter. Special bellows installations are available for weld splatter.



## Extended and Non-Standard Stroke Lengths

Where high linear speed is not crucial to the performance of the system, it may be possible to extend the standard length of any size actuator. Screw critical speed is a function of the diameter of the screw and the distance between its bearing supports. Additionally, non-standard or intermediate stroke lengths are available. Consult the factory for any special stroke needs.

## Special Lubricants

The Actuator Division has provided special lubrication for drive screws and thrust tubes as specified by the customer. Non-silicon based greases are available for clean room and vacuum-rated applications.

## Breather Tube Option

The aluminum actuator housing is an ideal platform for the installation of air fittings. Breather tubes may be fitted to either create positive pressurization (air purge) or create a vacuum to minimize particle contamination.

## Special Rod Seals

Substances in the application environment or the environment itself may unfavorably react with the combination lip and wiper seal on the thrust tube (rod). Special materials are available to suit most applications.

## High and Low Temperature Modifications

Aluminum and steel have different thermal expansion coefficients. It may be necessary to modify the fit tolerances on certain parts to accommodate extreme temperatures. Contact the factory if the application environment exceeds the recommended temperature range.

## External Linear Potentiometer

Attached to the cylinder by a standard bracket mount, the external linear potentiometer can accommodate stroke lengths from 100 to 1400mm. Repeatability is 0.01% of full stroke. Available in 4-20mA or 0-10 VDC, the enclosure has an IP67 rating and is designed to meet CE requirements.

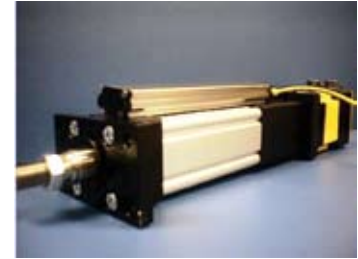

## Double Stack Angular Contact Bearings

Available with sizes 50 and 80 actuators. The standard 50 has a maximum thrust rating of 720 pounds of thrust and the 80 1600 pounds of thrust. By using a double stack of angular contact bearings, the 50 series will provide 900 pounds of thrust and the 80 series will provide 2500 pounds of thrust.

## IP65 Rating

The IP65 version is particularly suitable for washdown, external and contaminated environments in which the standard version could suffer long-term deterioration.

- Available for four sizes (32, 50, 80 & 100)
- Epoxy-coated cylinder body
- High performance dual position rod seal
- Optional metal scraper seal
- All external hardware in stainless steel
- Optional stainless steel rod ends and cylinder mountings
- Uses existing home and limit sensors
- Parallel or in-line motor mounting options retained
- Stroke length up to 1500mm
- Ballscrew pitches from 5-40mm/rev
- Thrust forces in excess of 20,000 N (4496 lbf)
- Speeds up to 2m/s
- High mechanical efficiency, typically 90%
- Some cylinder mountings not available with IP65 mounting. Consult factory.

## Clean Room Requirements

Clean room applications often require modifications to actuators to make the products permissible in clean room environments. Special lubricants, bearing materials, seals, motors and couplers may be required to prepare an actuator for clean room environments. Parker has tested the ET for clean room rating. Based off the actuator and the drive mechanics, Parker can provide 1000 to 10 clean rating. Please consult Actuator Division Application Engineering Department for further information.

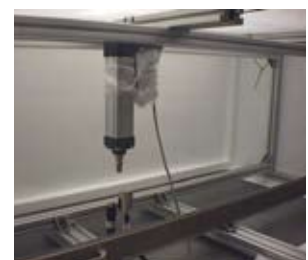



## Position Sensing Devices

ET Series actuators are equipped with permanent nitrile barium magnets on the bearing carriage. These magnets serve to activate available Hall Effect sensors or reed switches. ET Series actuators include dual sensor/switch mounting grooves on one side of the actuator (see figure 1). The ETB100 has grooves on all sides.

*Sensors must be ordered separately.*

## Comparing Sensors and Switches

Hall Effect	Reed
NO or NC	NO or NC
Fully adjustable travel	Fully adjustable travel
Solid state electronics	Mechanical reed
LED indicator	LED indicator
5-24 VDC	5-24VDC or 85-150 VAC
PNP and NPN	Low Amp and High Amp
Medium cost	Lowest cost
Long life	Medium life

## Dimensions

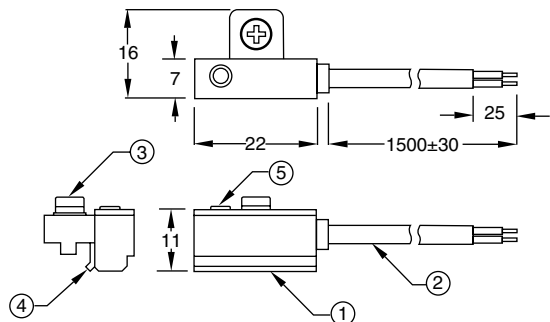

- Housing material: plastic
- Cable type: Ø3.3mm, 3C wire, 24AWG
- Clamp screw: M3x8mm, stainless steel
- Adjustable clamp: stainless steel
- LED color when activated: red
- IP67 and CE certified

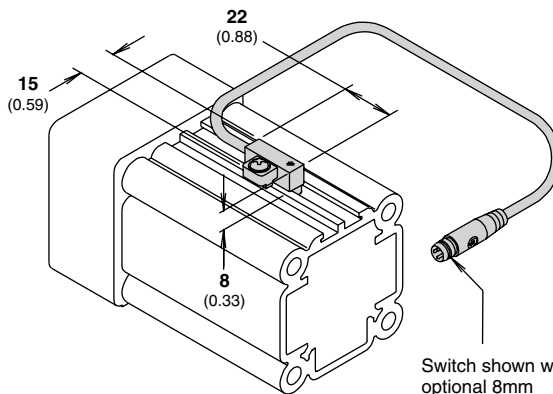
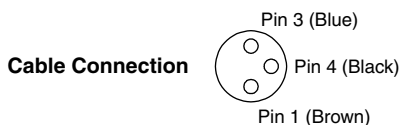
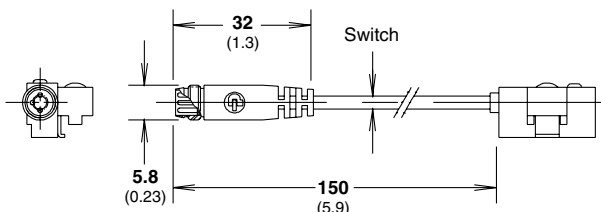

Figure 1

Switch shown with optional 8mm miniature 3-pin circular plug with universal snap-in/locking device. Flying lead also available.

## Hall Effect Sensors

Part No.	Type	LED Color	Logic	Cable/Connector
SMH-1P	N.O.	Green	PNP	1.5m black with leads
SMH-1N	N.O.	Red	NPN	
SMC-1P	N.C.	Yellow	PNP	
SMC-1N	N.C.	White/Red	NPN	150mm black with connector*
SMH-1PC	N.O.	Green	PNP	
SMH-1NC	N.O.	Red	NPN	
SMC-1PC	N.C.	Yellow	PNP	
SMC-1NC	N.C.	White/Red	NPN	

\* Order cable separately.

## Reed Switches

Part No.	Type	LED	Current Rating	Cable/Connector
SMR-1	N.O.	Green	High	1.5m gray with leads
SMR-1L	N.O.	Red	Low	
SMD-1L	N.C.	Yellow	Low	
SMR-1C	N.O.	Green	High	150mm gray with connector*
SMR-1LC	N.O.	Red	Low	
SMD-1LC	N.C.	Yellow	Low	

\* Order cable separately.

## Connector Option

A mating cable/connector is available for sensors with the connector option. Hall Effect sensors use all three wires while reed switches use only blue and brown.

Part No.	Description
B8786	5m (16 ft.) polyurethane covered cable/connector



## Hall Effect Sensors

Two types of Hall effect sensors are available for use with ET Series actuators. The normally open sensor is typically used for mid-position sensing, such as homing applications. The normally closed sensor is generally used to indicate over-travel at the end of the stroke, and is used in a safety circuit to prevent damage to components caused by over-travel.

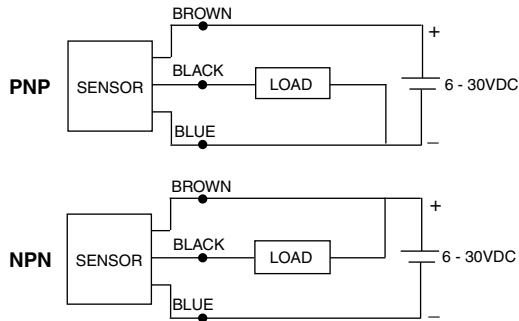

Note: End of travel sensors do not reduce available stroke.  
ZETA6104 controls use NPN sensors for Home and End-of-Travel.

## Hall Effect Specifications

	Solid State
Type	Solid State Type (PNP or NPN)
Switching Logic	Normally Open or Normally Closed
Supply Voltage Range	5 - 24 VDC
Switch Current	150 mA max
Current Consumption	7 mA at 12 VDC, 14 mA at 24 VDC
Switching Response	500 Hz Maximum
Residual Voltage	0.8 V Maximum (150 mA)
Leakage Current	10 uA Maximum
Insulation Resistance	100 M Ohm min.
Min. LED Current	1mA
Operating Temperature	-10° to 85°C (14° to 185°F)***
Lead Termination	1500 mm (60 in) or 150mm (6 in) w/connector
Industrial Protection	IP67
Shock Resistance	50 g's, 490 m/sec <sup>2</sup>

### Notes:

- \* Polarity is restricted for DC operation:  
(+) to Brown (-) to Blue  
If these connections are reversed for TTL levels the contacts will close, but the LED will not light.
- \*\* Due to minimum current requirement, LED will not display when used with all Gemini 6K and 6K products.
- \*\*\* Exceeds temperature range for ET Series mechanical components.

## Reed Switches

Reed switches are available in a normally open or normally closed configuration. The low amp switch is suitable for connection to PLCs or other low current devices. The high amp switch can be used to drive sequencers, relays, coils, or other devices directly. Not compatible with TTL level I.O. Logic (switch will work with TTL level if wired backwards but LED will not light).

### DC Operation

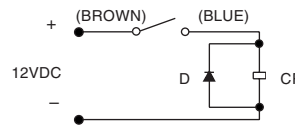

Required for proper operation 24VDC.

Put Diode parallel to load (CR) with polarity as shown.

D: Diode: select a Diode with the breakdown voltage and current rating according to the load.

CR: Relay coil (under 0.5 W coil rating)

### AC Operation

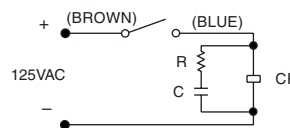

Recommended for longer switch life 125VAC.

Put resistor and capacitor parallel to load (CR).

CR: Relay coil (under 2 W coil ratings)

R: Resistor under 1 K Ohm

C: Capacitor 0.1 uF

## Reed Switch Specifications

	Low Amp	High Amp
Switching Logic	Normally Open (NO) Normally Closed (NC)	Normally Open (NO)
Voltage Rating	85-125 VAC (NO) 6-24 VDC* (NO) 6-24 VAC, 6-24 VDC* (NC)	85-125 VAC 6-24 VDC*
Power Rating	Resistive 10 Watts (NO) Inductive 5 Watts (NO) 3 Watts (NC)	Resistive load 10 Watts Inductive load 5 Watts
Switching Current Range	Resistive load: 5-40 mA (NO) 5-25 mA (NC) Inductive load 5-25 mA	Resistive load 30-300 mA Inductive load 30-100 mA
Min. LED Current	5 mA	18mA**
Switching Response	300 Hz (NO) 200 Hz (NC)	300 Hz max
Breakdown Voltage	200 VDC	
Contact Resistance	100 M Ohm min.	
Operating Temp.	-10° to 85°C (14° to 185°F)***	
Lead Termination	1500 mm (60 in) or 150mm (6 in) with connector	
Industrial Protection	IP67	
Shock Resistance	30 g's, 300 m/sec <sup>2</sup>	

# ET Ordering Information

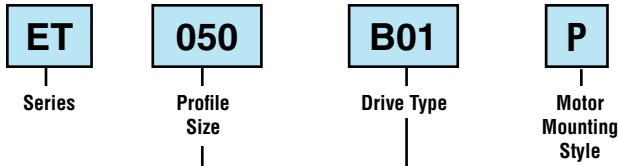

Code	Profile Size	Code	Drive Type
032	32mm	B02	Ball Screw, 0.500 in. Lead
		B08	Ball Screw, 0.125 in. Lead
		A04	Acme Screw, 0.250 in. Lead
		A08	Acme Screw, 0.125 in. Lead
050	50mm	B01	Ball Screw, 1.000 in. Lead
		B02	Ball Screw, 0.500 in. Lead
		B05	Ball Screw, 0.200 in. Lead
		A05	Acme Screw, 0.200 in. Lead
080	80mm	B01	Ball Screw, 1.000 in. Lead
		B02	Ball Screw, 0.500 in. Lead
		B04	Ball Screw, 0.250 in. Lead
		A04	Acme Screw, 0.250 in. Lead
100	100mm	B53	Ball Screw, 1.875 in. Lead
		B02	Ball Screw, 0.500 in. Lead
		B04	Ball Screw, 0.250 in. Lead
		A04	Acme Screw, 0.250 in. Lead
125	125mm	M50	Ball Screw, 50mm Lead
		M20	Ball Screw, 20mm Lead
		M10	Ball Screw, 10mm Lead
		M05	Ball Screw, 5mm Lead

3 For ET032, ET050 and ET080, switch mounting groove access will be obstructed. The cylinder body can be rotated in 90° increments to remedy this. However, at 90° and 270°, the load capacity of the rod is reduced by half due to roller bearing orientation. At 180° the side load is unchanged.

Code	Motor Mounting Style
L	Inline
P	Parallel, Position P <sup>3</sup>
M	Parallel, Position M
N	Parallel, Position N
Q	Parallel, Position Q
R	Reverse Parallel, Position R
S	Reverse Parallel, Position S
T	Reverse Parallel, Position T
V	Reverse Parallel, Position V

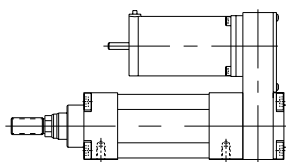
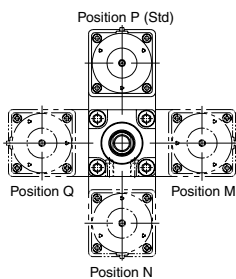

Parallel Mounting Positions (as viewed from the rod end)



Continued on next page

Code	Gearbox Option <sup>1</sup>	Code	Gearbox Ratio
A	PX23	00	Flange Only <sup>2</sup>
B	PS60 - Shaft Horizontal	03	3:1
C	PS60 - Shaft Vertical	04	4:1
D	PX34	05	5:1
E	PS90 - Shaft Horizontal	07	7:1
F	PS90 - Shaft Vertical	10	10:1
G	PX115	15	15:1
H	PS115 - Shaft Horizontal	20	20:1
J	PS115 - Shaft Vertical	25	25:1
K	PX56	30	30:1
L	PS142 - Shaft Horizontal	40	40:1 (PS only)
M	PS142 - Shaft Vertical	50	50:1
P	PV23FE	70	70:1
Q	PV34FE	A0	100:1
0	No Gearbox		

1 Not all motor/gearbox options physically fit on all cylinder sizes and mounting styles. Reference mounting matrix to determine suitable combinations. PS precision gearboxes are oil filled. Shaft orientation is required to insure proper oil fill levels.

2 When combined with Gearbox Option "0" (no gearbox), this option is direct mount with no flange included.

Code	Drive Ratio
A	1:1 Inline 1:1 Timing Belt (Parallel)
Z	1:1.5 Timing Belt (32 Parallel)
B	1.5:1 Timing Belt (50, 80 Parallel)
D	2:1 Timing Belt (50, 80 Parallel)
K	1:1 Gear Drive (32, 50, 80 Parallel)
E	3:1 Gear Drive (32, 50, 80 Parallel)
F	5:1 Gear Drive (32, 50, 80 Parallel)
G	7.5:1 Gear Drive (32, 50, 80 Parallel)
H	9.5:1 Gear Drive (32, 50 Parallel) 10:1 Gear Drive (80 Parallel)

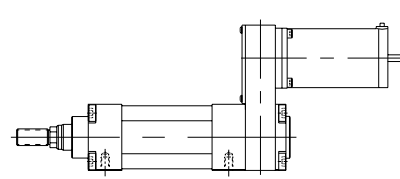

Reverse Parallel Mounting Positions (as viewed from the shaft end)

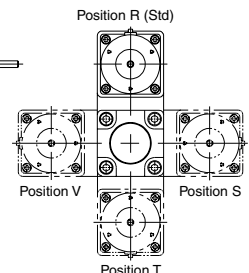

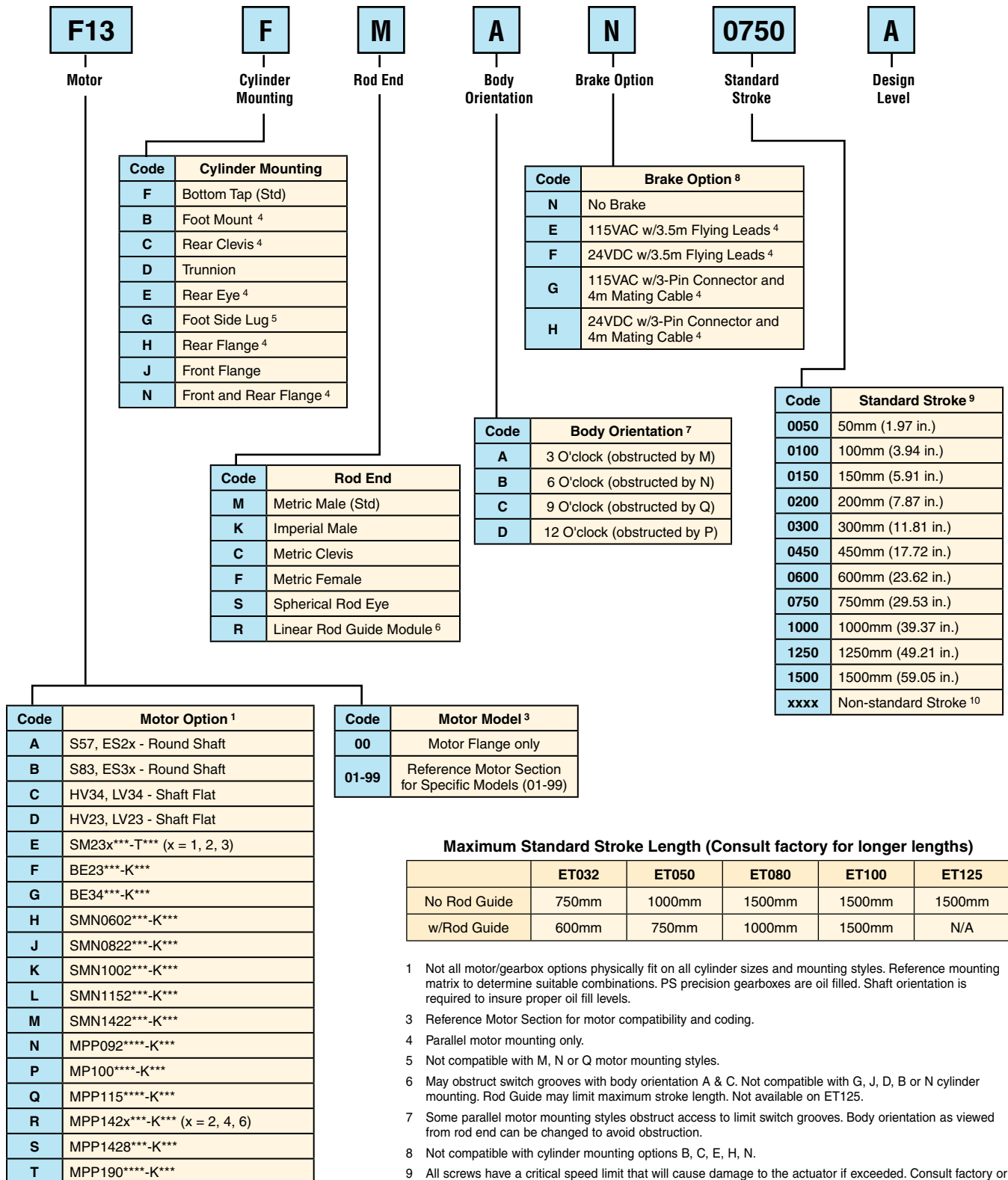

# ET Application Fax Form



Fax completed form to (330) 334-3335 or email to [actuatorsales@parker.com](mailto:actuatorsales@parker.com)

## Contact Information:

Name \_\_\_\_\_ Phone \_\_\_\_\_  
 Company \_\_\_\_\_ email \_\_\_\_\_  
 City, State, Zip \_\_\_\_\_

## Application Sketch

### NOTES:

Please include the critical dimensions in your sketch.

In order to achieve the best solution, it is important that you provide as much information as possible.

## Motion Profile

Moves	Distance (Stroke)	Time	Thrust or Load	Dwell
First Motion				
Second Motion				
Third Motion				
Fourth Motion				

### Max. Rod Side Load

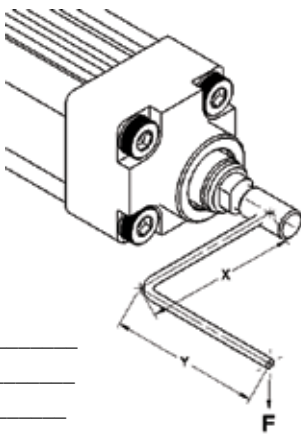

- a. X distance \_\_\_\_\_
- b. Y distance \_\_\_\_\_
- c. Force \_\_\_\_\_

### Application Requirements:

1. Overall Stroke (add 25mm per end minimum) \_\_\_\_\_
2. Cylinder Orientation (check one)
  - Horizontal
  - Angle: Degrees \_\_\_\_\_  Shaft Up  Shaft Down
  - Vertical:  Shaft Up  Shaft Down
3. Load/Tooling Weight \_\_\_\_\_
4. Repeatability Requirements \_\_\_\_\_
  - Unidirectional  Bidirectional
5. Is the load externally guided? (check one)
  - Yes  No
  - If yes, how? \_\_\_\_\_
6. Life Requirements (cycles, distance or years)
  - Hours per day \_\_\_\_\_ Days per year \_\_\_\_\_
7. Type of Screw
  - Acme  Ball Screw
8. Special Considerations \_\_\_\_\_  
 \_\_\_\_\_  
 \_\_\_\_\_  
 \_\_\_\_\_

### Environmental Requirements

1. Operating Temperature
  - Max \_\_\_\_\_ Min \_\_\_\_\_
2. Contamination (check one)
  - Particle  Liquid
  - Type: \_\_\_\_\_
3. Special Considerations \_\_\_\_\_  
 \_\_\_\_\_  
 \_\_\_\_\_

Please attach another sheet if more room is needed.

## Cylinder Requirements

### 1. Rod End (check one)

Metric Male (std)



Metric Female



Metric Clevis



Spherical Rod Eye



Linear Rod Guide



Imperial Male



Other \_\_\_\_\_

### 2. Mounting Style (check one) — \* = Parallel Motor Mount only

Bottom Tap (std)

Foot Mount\*

Trunnion



Front Flange



Rear Flange\*



Foot Side Lug



Rear Eye\*



Rear Clevis\*



Other \_\_\_\_\_

### 3. Motor Mounting (check one)

Inline Mount

Parallel Mount Position \_\_\_\_\_

Parallel mounts can limit the actuator's total thrust capacity.

Parallel mount is also available in Reverse Parallel configuration. See catalog page 24.

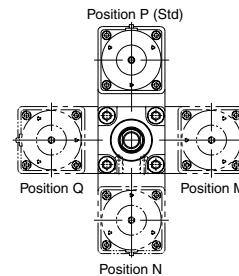

## Motor, Drive and Control Options:

### 1. Motor Options (check all that apply)

Stepper

Servo

Parker Supplied

Customer Supplied (provide print)

Gearhead

### 2. Other Options (check one)

Drive

Drive/Controller

Controller

### 3. Available Line Voltage \_\_\_\_\_

### 4. Switches/Sensors (quantity)

End of Travel \_\_\_\_\_

Home \_\_\_\_\_

### 5. Brake Option (check one)

Actuator\*

Motor

None

\*With parallel motor mount only

### 6. Special Options \_\_\_\_\_

\_\_\_\_\_  
 \_\_\_\_\_  
 \_\_\_\_\_

